

CONNECTION DIAGRAM FOR HEATING ELEMENTS
 VASTUUSIEN KYTKENTÄOHJE ERI JÄNNITEJÄRJESTELMILLÄ

3/PE 220-230V 50Hz
 K1/1-K1/5

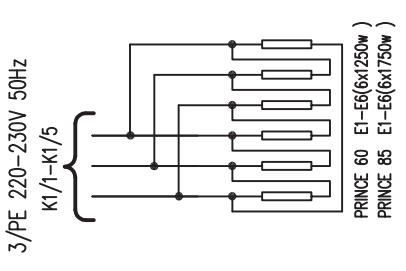

3/N/PE 380-415V 50Hz
 3/PE 380-415V 50Hz
 K1/1-K1/5

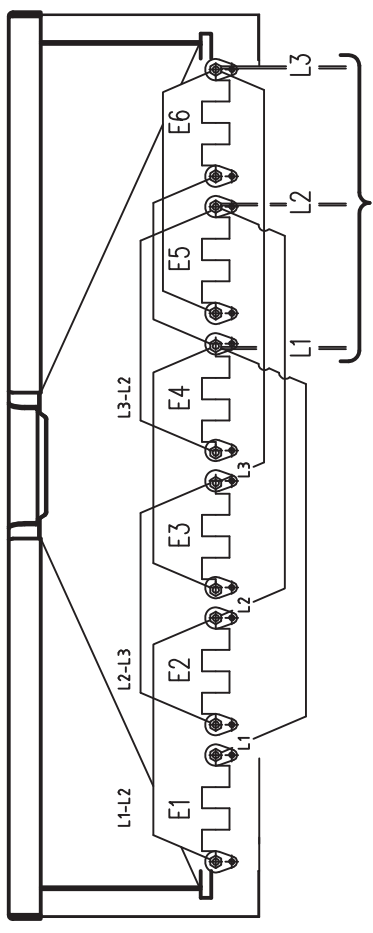
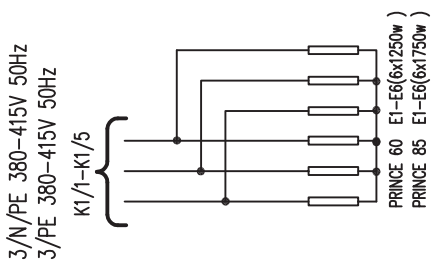
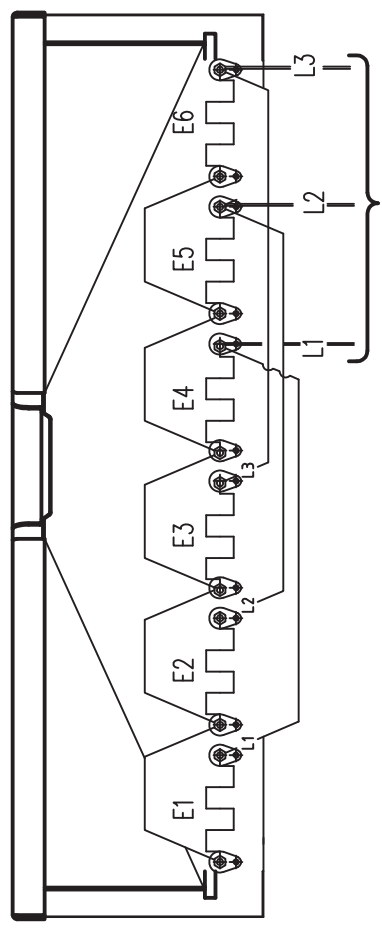

3/PE 440V 50-60Hz
 K1/1-K1/5

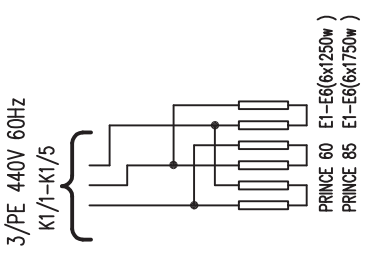
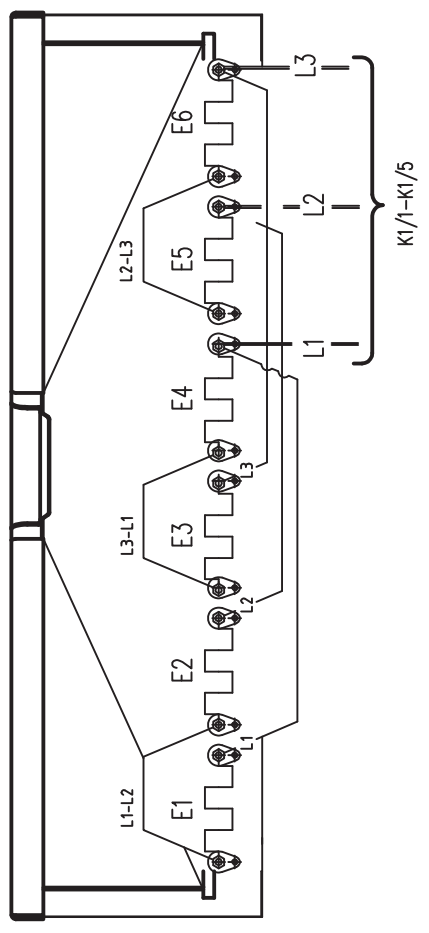

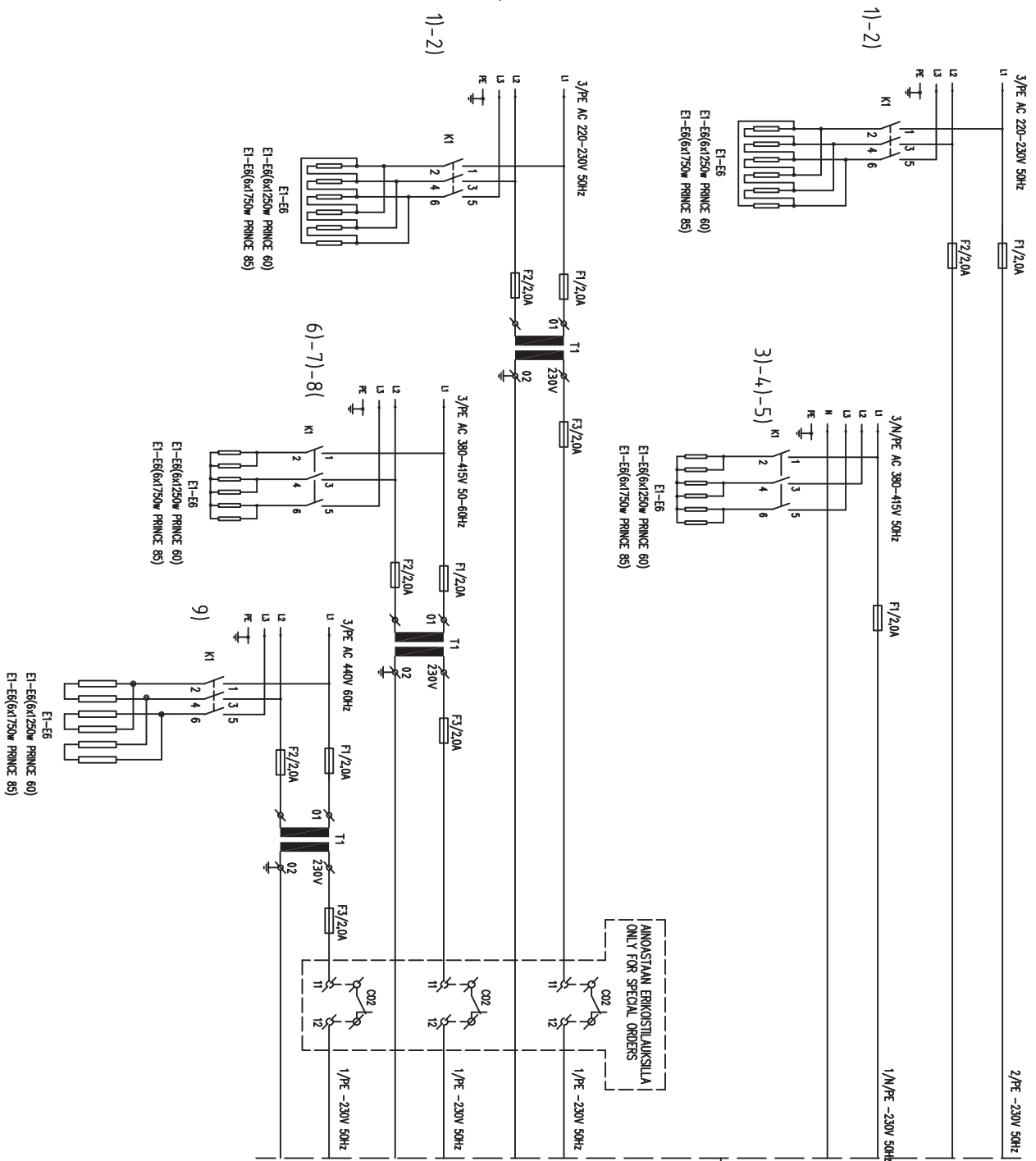

LIITÄNTÄYTÖT/CONNECTION INFORMATION
Yrjö- ja tehoteidot uunille ja ryhmille
Supply current- and power

KAAVIO DIAGRAM N:o	VERKKO / ELECTRIC SUPPLY	PRINCE 60		PRINCE 85	
		P /kW	I /A	P /kW	I /A
1	3/PE AC 220V 50-60Hz	6,9	18,0	9,6	25,2
2	3/PE AC 230V 50-60Hz	7,5	18,8	10,5	26,3
3	3/N/PE AC 380V 50Hz	6,9	10,4	9,6	14,6
4	3/N/PE AC 400V 50Hz	7,5	10,9	10,5	15,2
5	3/N/PE AC 415V 50Hz	8,2	11,3	11,5	15,9
6	3/PE AC 380V 50Hz	6,9	10,4	9,6	14,6
7	3/PE AC 400V 50Hz	7,5	10,9	10,5	15,2
8	3/PE AC 415V 50Hz	8,2	11,3	11,4	15,9
9	3/PE AC 440V 60Hz	6,9	9,0	9,6	12,6

-HACKMAN-
METOS

Tuote	0122011A.0	PAISTINPANNU PRINCE 60,60H,85,85H
Tuote	BRATT PAN PRINCE 60,60H,85,85H	
Yht.	STEKBORD PRINCE 60,60H,85,85H	

Kytentäkaavio
Connection diagram
Kopplingschema

Yrjö	T02711A3	Lait	3/1
Pr.-yht.	T02711A3	Sheet	
Rev		Rev	

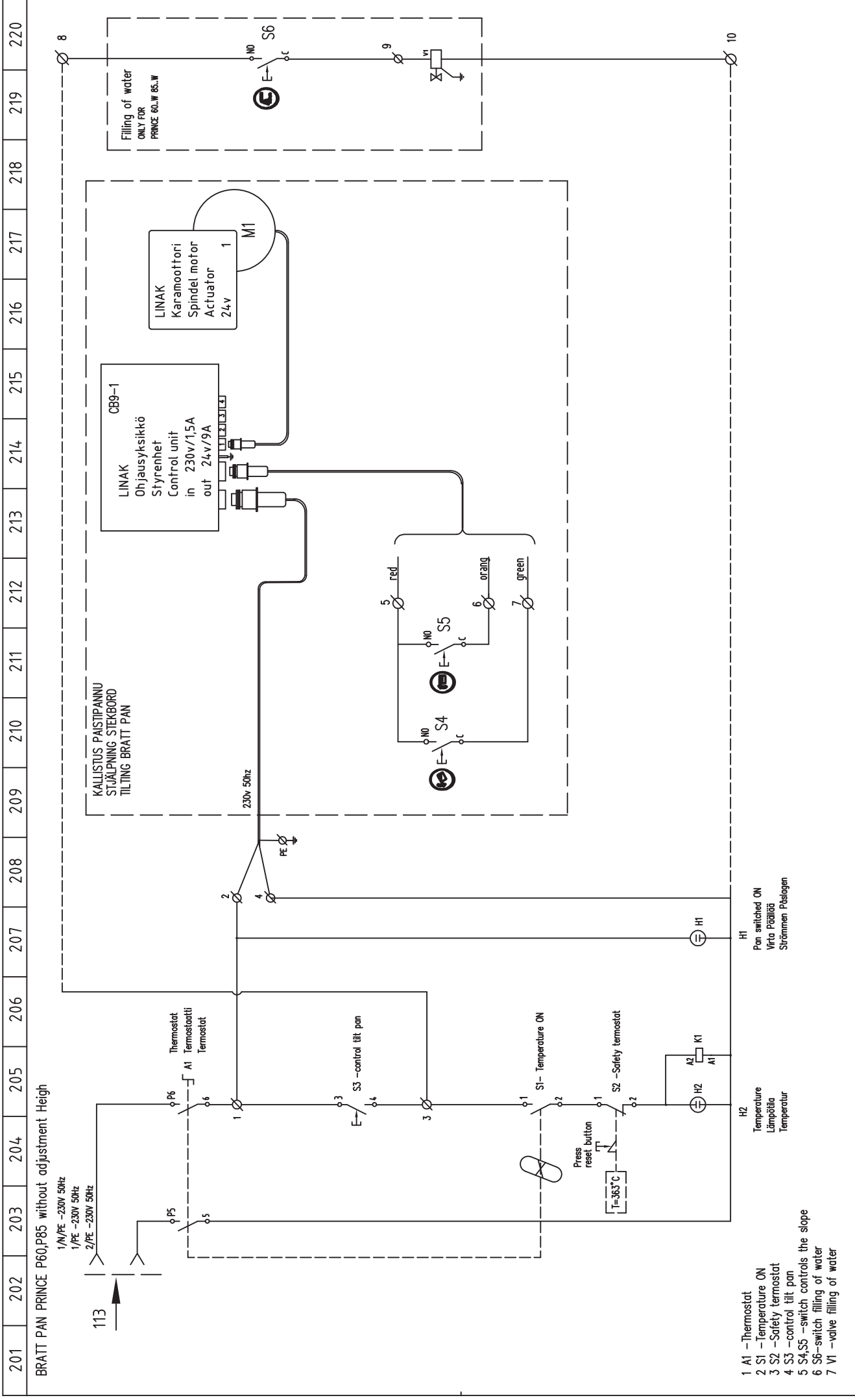

- 1 A1 -Thermostat
- 2 SI -Temperature ON
- 3 S2 -Safety thermostat
- 4 S3 -control tilt pan
- 5 S4,S5 -switch controls the slope
- 6 S6-switch filling of water
- 7 V1 -valve filling of water

201	202	203	204	205	206	207	208	209	210	211	212	213	214	215	216	217	218	219	220
BRATT PAN PRINCE P60,P85 without adjustment Height										KALLISTUS PAISTIPANNU STJÄLPNING STEKBORD TILTING BRATT PAN									
1/N/PE -230V 50Hz 1/PE -230V 50Hz 2/PE -230V 50Hz										LINAK Ohjausyksikkö Control unit in 230v/15A out 24v/9A									
Thermostat A1 Termostaatti Termostaat										LINAK Karamoottori Spindel motor Actuator 24v									
3 S3 -control tilt pan										M1									
SI - Temperature ON										5 red									
Press reset button T=36.3°C										6 orange									
S2 -Safety thermostat										7 green									
H2 Temperature Lämpötila Temperatur										S4									
H1 Pan switched ON Virvo Päälägi Strömmen Påslagen										S5									
K1										S6									
Filling of water ONLY FOR PRINCE 60..W 85..W										V1									
8										9									
10																			
113																			
1/N/PE -230V 50Hz 1/PE -230V 50Hz 2/PE -230V 50Hz										3/PE AC 220-230V 50Hz									
										3/N/PE AC 380-415V 50Hz									
										3/PE AC 380-440V 50-60Hz									
Kytentäkaavio Connection diagram Kopplingschema										T02711A3									
PAISTIPANNU PRINCE 60,85 BRATT PRINCE 60,85 STEBORD PRINCE 60,85										T02711A3									
Tila DESIGN 07.12.2011/A.O										Pih. nro D616 BR									
Tila CHD										Lait. SHEET									
Tyyppi BRP										REV									
-HACKMAN- METOS										3/PE AC 220-230V 50Hz									
										3/N/PE AC 380-415V 50Hz									