

# metos

## CORONA BUFFET

REFRIGERATED CB  
REFRIGERATED UNIT WITH UPPER SECTION CBUS  
BAIN-MARIE BM  
BAIN-MARIE WITH UPPER SECTION BMUS  
NEUTRAL SB  
NEUTRAL UNIT WITH UPPER SECTION N  
HEATED PLATE DISPENSER PDW  
NEUTRAL PLATE DISPENSER PD

---

### Installation and Operation Manual

---



---

S/N: 10990901010010

Valid from: 01. 01. 2009

Rev.: 1.0

4309802, 4309806, 4309810, 4309814, 4309804, 4309808, 4309812, 4309816, 4309818, 4309822, 4309826, 4309830,  
4309820, 4309824, 4309828, 4309832, 4309842, 4309844, 4309846, 4309848, 4309834, 4309836, 4309838, 4309840,  
4309850, 4309854, 4309852, 4309856



Dear Customer,

Congratulations on deciding to choose a Metos appliance for your kitchen activities. You made an excellent choice. We will do our best to make you a satisfied Metos customer like thousands of customers we have around the world.

Please read this manual carefully. You will learn correct, safe and efficient working methods in order to get the best possible benefit from the appliance. The instructions and hints in this manual will give you a quick and easy start, and you will soon note how nice it is to use the Metos equipment.

All rights are reserved for technical changes.

You will find the main technical data on the rating plate fixed to the equipment. When you need service or technical help, please let us know the serial number shown on the rating plate. This will make it easier to provide you with correct service.

For your convenience, space is provided below for you to record your local Metos service contact information.

METOS TEAM

Metos service phone number:.....

Contact person:.....



<b>1. General .....</b>	<b>1</b>
1.1 Symbols used in the manual .....	1
1.2 Symbols used on the appliance .....	1
1.3 Checking the relationship of the appliance and the manual .....	1
<b>2. Safety .....</b>	<b>2</b>
2.1 Safe use of the appliance .....	2
2.2 Disposal of the appliance .....	2
<b>3. Functional description .....</b>	<b>3</b>
3.1 Intended use of the appliance .....	3
3.1.1 Use for other purposes .....	3
3.2 Functional description .....	3
<b>4. Operating instructions .....</b>	<b>4</b>
4.1 Operation .....	4
4.1.1 Refrigerated CB and CBUS .....	4
4.1.2 Bain-marie BM and BMUS .....	4
4.1.3 Heated plate dispenser PDW .....	5
4.2 After use .....	5
4.2.1 Emptying the basin .....	5
4.2.2 Cleaning .....	5
4.2.3 Replacing the lamp (CBUS, N, BMUS) .....	7
4.2.4 Adjustment of spring mechanism .....	7
4.2.5 Diameter adjustment (accessory) .....	8
<b>5. Installation .....</b>	<b>10</b>
5.1 Operating conditions .....	10
5.2 Transport and storage .....	10
5.3 Installation .....	10
5.4 Unpacking the appliance .....	11
5.5 Electrical connections .....	11
5.6 Start-up .....	11
5.6.1 Refrigerated CB and CBUS, bain-marie BM and BMUS, neutral N, heated plate dispenser PDW .....	11
<b>6. Troubleshooting .....</b>	<b>12</b>
<b>7. Technical specifications .....</b>	<b>13</b>



# 1. General

Carefully read the instructions in this manual as they contain important information regarding proper, efficient and safe installation, use and maintenance of the appliance.

Keep this manual in a safe place for eventual use by other operators of the appliance.

The installation of this appliance must be carried out in accordance with the manufacturer's instructions and following local regulations. The connection of the appliance to the electric and water supply must be carried out by qualified persons only.

Persons using this appliance should be specifically trained in its operation.

Switch off the appliance in case of failure or malfunction. The periodical function checks requested in the manual must be carried out according to the instructions. Have the appliance serviced by a technically qualified person authorized by the manufacturer and using original spare parts.

Not complying with the above may put the safety of the appliance in danger.

## 1.1 Symbols used in the manual



This symbol informs about a situation where a safety risk might be at hand. Given instructions are mandatory in order to prevent injury.



This symbol informs about the right way to perform in order to prevent bad results, appliance damage or hazardous situations.



This symbol informs about recommendations and hints that help to get the best performance out of the appliance.

## 1.2 Symbols used on the appliance



This symbol on a part informs about electrical terminals behind the part. The removal of the part must be carried out by qualified persons only.

## 1.3 Checking the relationship of the appliance and the manual

The rating plate of the appliance indicates the serial number of the appliance. If the manuals are missing, it is possible to order new ones from the manufacturer or the local representative. When ordering new manuals it is essential to quote the serial number shown on the rating plate.

## 2. Safety

### 2.1 Safe use of the appliance



For safe use of the appliance, observe the following safety instructions:

- When moving or servicing the appliance, always unplug it from the power supply.
- While cleaning the appliance, be cautious not to allow the electrical devices to come into contact with water. Spraying water in the immediate vicinity of the appliance is forbidden.
- Exposing the appliance to the rain is forbidden.

If the appliance is not used for a long time, it should be unplugged from the power supply, cleaned and wiped dry on the inside.

### 2.2 Disposal of the appliance

The appliance contains parts and components, the disposal of which requires special treatment. Contact local authorities to obtain instructions on how to dispose of the appliance.



## 3. Functional description

### 3.1 Intended use of the appliance

Corona Buffet is intended for short-time storage and distribution of foodstuffs in dining rooms and restaurants.

The plate dispenser is intended for storage and distribution of plates. The max. diameter of plates is 270 mm.



The manufacturer shall not be held liable for situations which may arise from failure to comply with the warnings and instructions given in this manual.

#### 3.1.1 Use for other purposes



Use of the appliance for any other purposes is prohibited.

Consult the manufacturer in case you intend to use the appliance for other purposes than stated above.

### 3.2 Functional description

The operation of the refrigerated buffet trolley is based on a copper tube located around the edges of the cold basin, acting as an evaporator. Normally the refrigerated buffet is supplied with a cooling unit of its own, but by special order it can be equipped with an option for central refrigeration attachment.

The operation of the heated buffet trolley is based on conveying steam from the heating element located in the bottom of the basin to the bottom of the container for keeping the food warm.

The counter force of the plate dispenser is provided by metal springs. The heated model is equipped with a heating element for warming up the plate compartment.

## 4. Operating instructions

### 4.1 Operation

#### 4.1.1 Refrigerated CB and CBUS

Before placing products in the unit, wait until it has reached the temperature set with the thermostat.

Correct cold storage of foodstuffs facilitates kitchen activities and affects energy consumption:

- Do not load products until the appliance has reached the correct operating temperature.
- Monitor the internal temperature of the unit daily.
- Always keep the products in good order.
- Do not store spoiled food in the unit.
- Always preserve the products in dishes fitted with lids or cover them with a plastic foil. This will prevent unnecessary drying of food.

In normal conditions, the thermostat need not be adjusted.

#### 4.1.2 Bain-marie BM and BMUS

Before placing products in the unit, wait until it has reached the temperature set with the thermostat.

Correct storage of foodstuffs facilitates kitchen activities and affects energy consumption:

- Do not load products until the appliance has reached the correct operating temperature.
- Monitor the internal temperature of the unit daily.
- Always keep the products in good order.
- Do not store spoiled food in the unit.
- Always preserve the products in dishes fitted with lids or cover them with a plastic foil. This will prevent unnecessary drying of food.

In normal conditions, the thermostat need not be adjusted.

## Operating instructions

---

Close the water valve and fill the basin with hot water to the level of 3-5 cm from the bottom.



Never use the bain-marie without water in the basin.



When emptying the basin, beware of hot water.



GN containers or lids should be used on top of the basin to maintain the correct storage temperature.

### 4.1.3 Heated plate dispenser PDW

- Put the plates in the unit and adjust the temperature desired.
- Monitor the temperature of the unit daily.
- Always keep the plates in good order.

In normal conditions, the thermostat need not be adjusted.

## 4.2 After use

### 4.2.1 Emptying the basin

The unit has a drain valve beneath the basin. Water can be emptied by opening this valve. The units are fitted with a 1 m drain hose to carry water into an emptying vessel. The emptying vessel should be placed either behind the service door inside the unit or, if not enough space is available, the vessel should be positioned beside the unit for the duration of emptying.

If the unit has not been connected to the sewage system, it is extremely important to keep the drain valve tap closed at all times except during emptying, particularly when the unit has been installed on a water-sensitive floor surface, such as parquet.

### 4.2.2 Cleaning

#### Refrigerated CB and CBUS

In normal use, the appliance does not require any other daily care than sufficient cleaning.

For cleaning the interior and exterior, use neutral or slightly alkaline cleaning agents or wipe the surfaces with a damp cloth. Abrasive materials should not be used, especially not on acrylic surfaces.



Use of a hose for cleaning the appliance is forbidden.

Clean the condenser once a week. The machinery does not normally require any other cleaning.



Before vacuum-cleaning the condenser, switch off the appliance at the mains by unplugging the electric cable from the socket.



Other cleaning measures than the condenser cleaning should be carried out by an authorised service workshop.



It is recommended to have the compressor cassette cleaned inside by a service company 1-2 times a year.

### **Bain-marie BM and BMUS, plate dispensers PDW and PD**

In normal use, the appliance does not require any other daily care than sufficient cleaning.

For cleaning the interior and exterior, use neutral or slightly alkaline cleaning agents or wipe the surfaces with a damp cloth. Abrasive materials should not be used, especially not on acrylic surfaces.



Use of a hose for cleaning the appliance is forbidden.

### **Neutral SB and N**

In normal use, the appliance does not require any other daily care than sufficient cleaning.

For cleaning the interior and exterior, use neutral or slightly alkaline cleaning agents or wipe the surfaces with a damp cloth. Abrasive materials should not be used, especially not on acrylic surfaces.



Use of a hose for cleaning the appliance is forbidden.

### 4.2.3 Replacing the lamp (CBUS, N, BMUS)



Switch off the luminaire at the mains before replacing the lamp.

To avoid damaging the starter, it is advisable to replace the lamp before the end of its service life. The starter cannot be replaced.

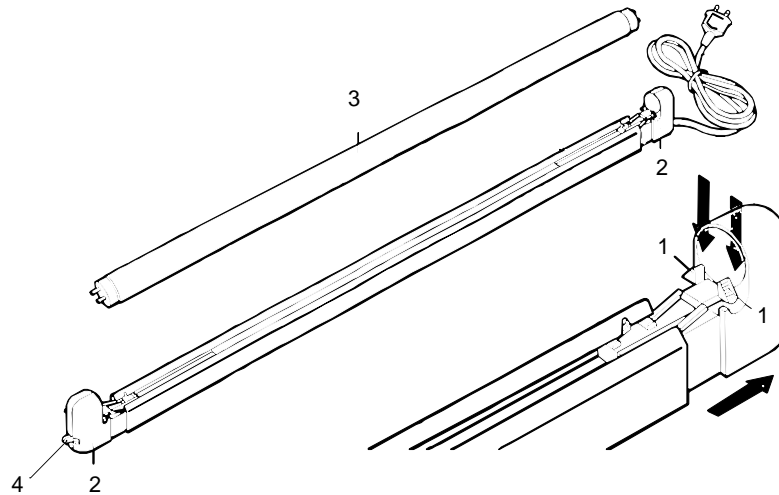

1. Lever
2. Lamp holder
3. Lamp
4. Switch

Hold down the levers, slide both ends of the lamp holder sideways and remove the lamp. Insert the lamp and return both lamp holders to their original position, making sure they snap into place.

### 4.2.4 Adjustment of spring mechanism

Switch off the appliance (PDW).

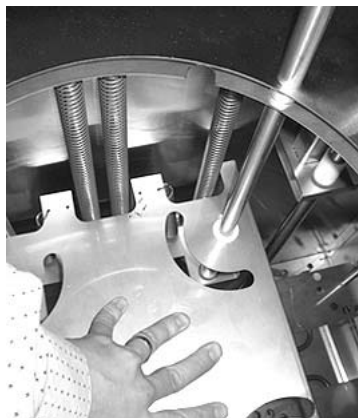

To access the springs, press an empty cylinder with your hand.

There is a hole in the dish platform for reserve springs to keep them in place.

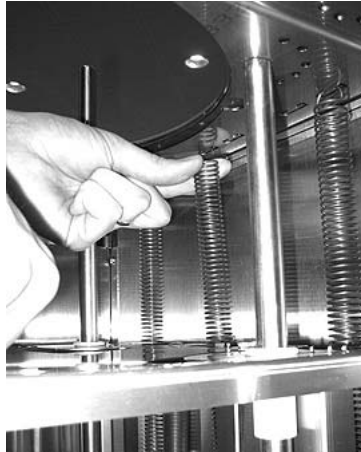

Hold the spring with a firm grip and set it in the position desired.

The spring is placed in a C-shaped notch located in the cover.

Spring pressure should be distributed as evenly as possible on the whole lifting mechanism.

#### 4.2.5 Diameter adjustment (accessory)



Detach the dispenser cover by untwisting the support bars (4 pcs/cylinder) which hold the cover in place.

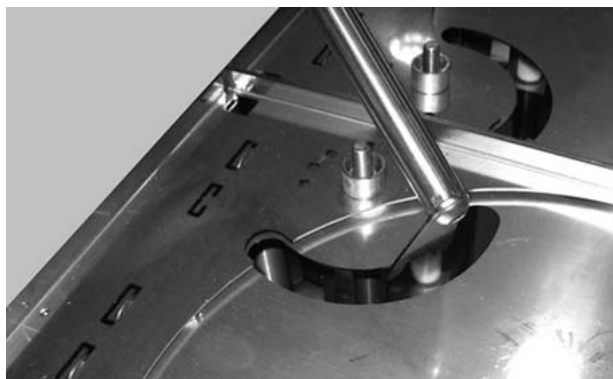

Slide the adjustment rods (4 pcs/cylinder) in place. You do not need to remove the cylinder from the appliance.

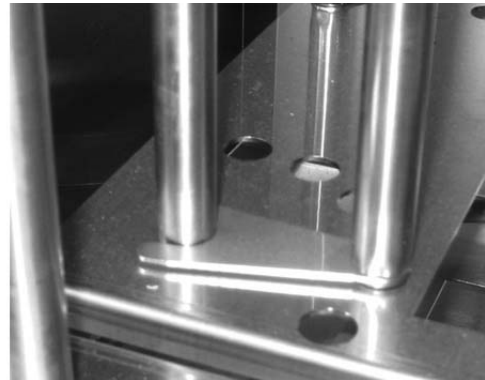

Lift the rod and turn it into the position desired. There are guide studs at the upper and lower end of the adjustment rod to ensure the correct location of the rod.

Do not switch the appliance on until the dispenser mechanism is in its correct place in the unit (PDW).

Adjustment options for 270 mm cylinders: 180/200/220/235/270 mm

Adjustment options for 320 mm cylinders: 240/250/270/285/320 mm

## 5. Installation

### 5.1 Operating conditions

The appliance is designed for operation at temperatures of +10°C to + 25°C.

**Refrigerated CB and CBUS:** The appliance should not be placed close to bain-maries or ovens.

### 5.2 Transport and storage

The appliance should be transported to the installation site in its transport package. Do not remove package until in the immediate vicinity of the installation place. The appliance should be transported in an upright position.

The appliance is made of polished stainless steel, melamine plate and tempered glass, so it can become scratched very easily in site conditions. Therefore, the appliance should be delivered to the installation site at a later stage of construction work. It is forbidden to use the appliance as an installation base.



The appliance should not be stored outdoors, not even in its transport package.

#### **Refrigerated CB and CBUS**



In case the appliance has been stored in a non-heated location so that its temperature and particularly the temperature of the machinery has fallen below 0°C, the appliance should be kept in room temperature until the machinery temperature is at least 10°C. Starting the cold machinery may damage the compressor.



In case the appliance has been heavily tilted just before the intended start-up, you should wait at least 30 minutes before switching the appliance on. Otherwise the oil accumulated in the suction inlets of the compressor may damage the compressor with a hydraulic shock.

### 5.3 Installation

The appliance is fitted with castors. Mount the appliance on an even surface.

**Refrigerated CB and CBUS:** Ensure free air circulation for the condenser.



---

## 5.4 Unpacking the appliance

Remove foils protecting the stainless steel and plastic surfaces cautiously to prevent the surfaces from getting scratched.

## 5.5 Electrical connections

The connection cable is located behind the end plate. Connect the appliance to the power supply with an earthed socket. In models with an upper section the light will turn on automatically. For making the connection, a socket protected with a fuse of max. 16 A has to be provided for each unit.

When units are installed in serving lines, you can put the connection cable in the holders provided with the help of a cable tie.

## 5.6 Start-up

### 5.6.1 Refrigerated CB and CBUS, bain-marie BM and BMUS, neutral N, heated plate dispenser PDW

After connecting the appliance to the power supply, turn on the main switch (green) and make sure that the indicator light of the switch lights up.

In case you have problems with taking the appliance into use, contact the Metos service.

## 6. Troubleshooting

In case the appliance does not function as expected, review the following list of problems to find out if the appliance can be put in order without a service call. In all enquiries, please contact the nearest Metos service. Most problems can be managed on the phone.

PROBLEM	POSSIBLE CAUSE	ACTION
The appliance does not start even if the main switch is turned on.	Electric cable is not properly plugged in the socket.	Put the cable properly in the socket.
	Defective fuse.	Replace the fuse.
Refrigerated CB and CBUS: Compressor is running, but the temperature does not fall to the set value	Condenser covered by dust.	Vacuum-clean the condenser.
	Ambient temperature exceeds the maximum value (+25°C).	Make sure that the appliance has not been placed close to a heat source. If necessary, provide mechanical ventilation.
	Prevented air circulation beside the condenser.	Remove obstacles to ensure free air circulation.
Bain-marie BM and BMUS: Water in the basin does not heat, even if the pilot lamp of the switch lights up.	There is or has not been enough water in the basin during heating.	Add hot water until water level is at least 5 cm from the bottom.
	Overheat protection has activated.	Reset the overheat protection.
Bain-marie BM and BMUS: Food does not remain hot enough.	Too much water in the basin.	Decrease water to the correct level.
	Water basin partly open.	Cover the basin with lids or containers.



The appliance does not contain parts that can be serviced by the user. Service must be carried out by an authorised service company.

## **7. Technical specifications**

**Installation drawing U00258 A3**

**Installation drawing U00314 A3**

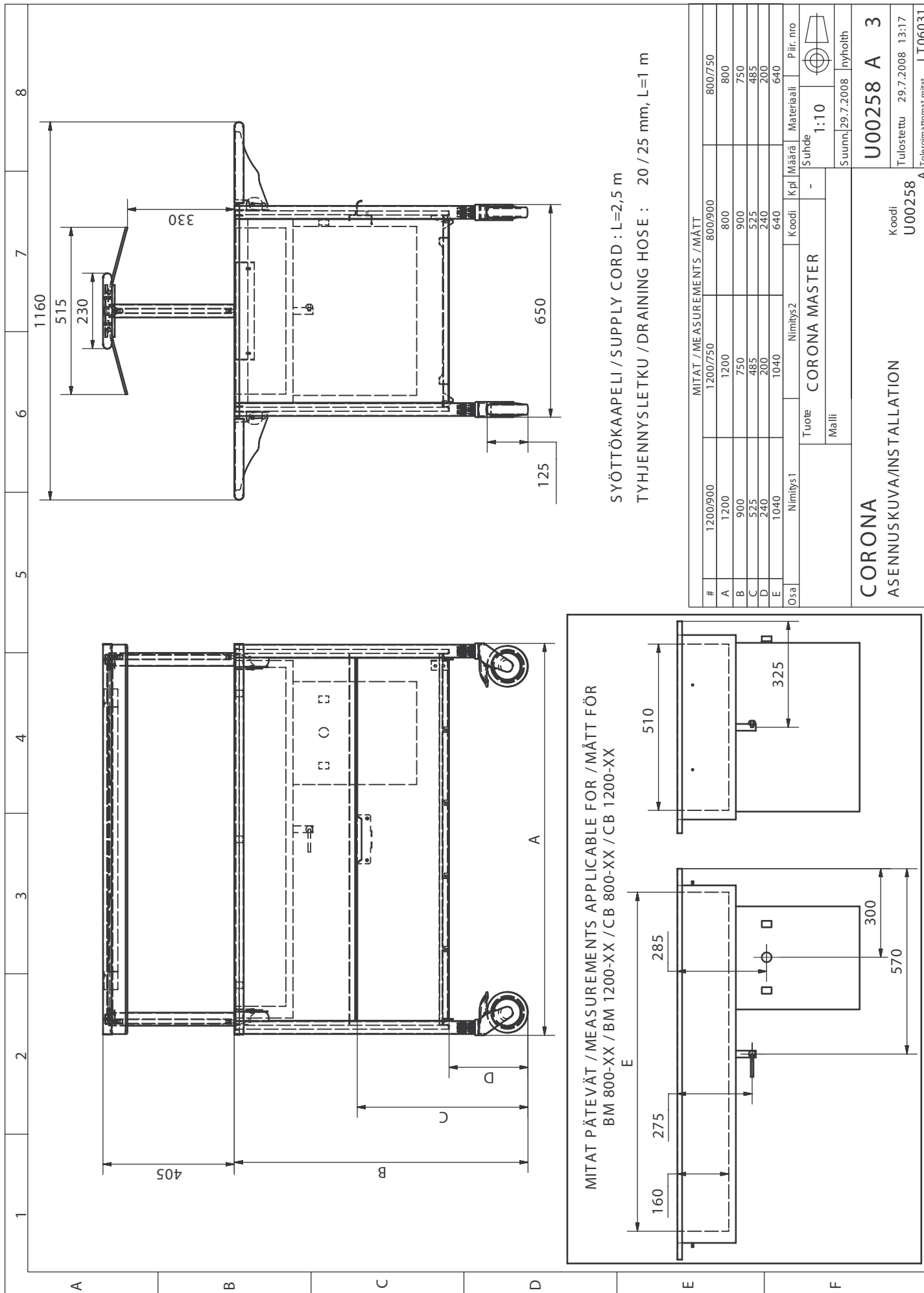

SYÖTTÖKAAPPELI / SUPPLY CORD : L=2,5 m  
 TYHJENNYSLITKU / DRAINING HOSE : 20 / 25 mm, L=1 m

MITAT PÄTEVÄT / MEASUREMENTS APPLICABLE FOR / MÅTT FÖR  
 BM 800-XX / BM 1200-XX / CB 800-XX / CB 1200-XX

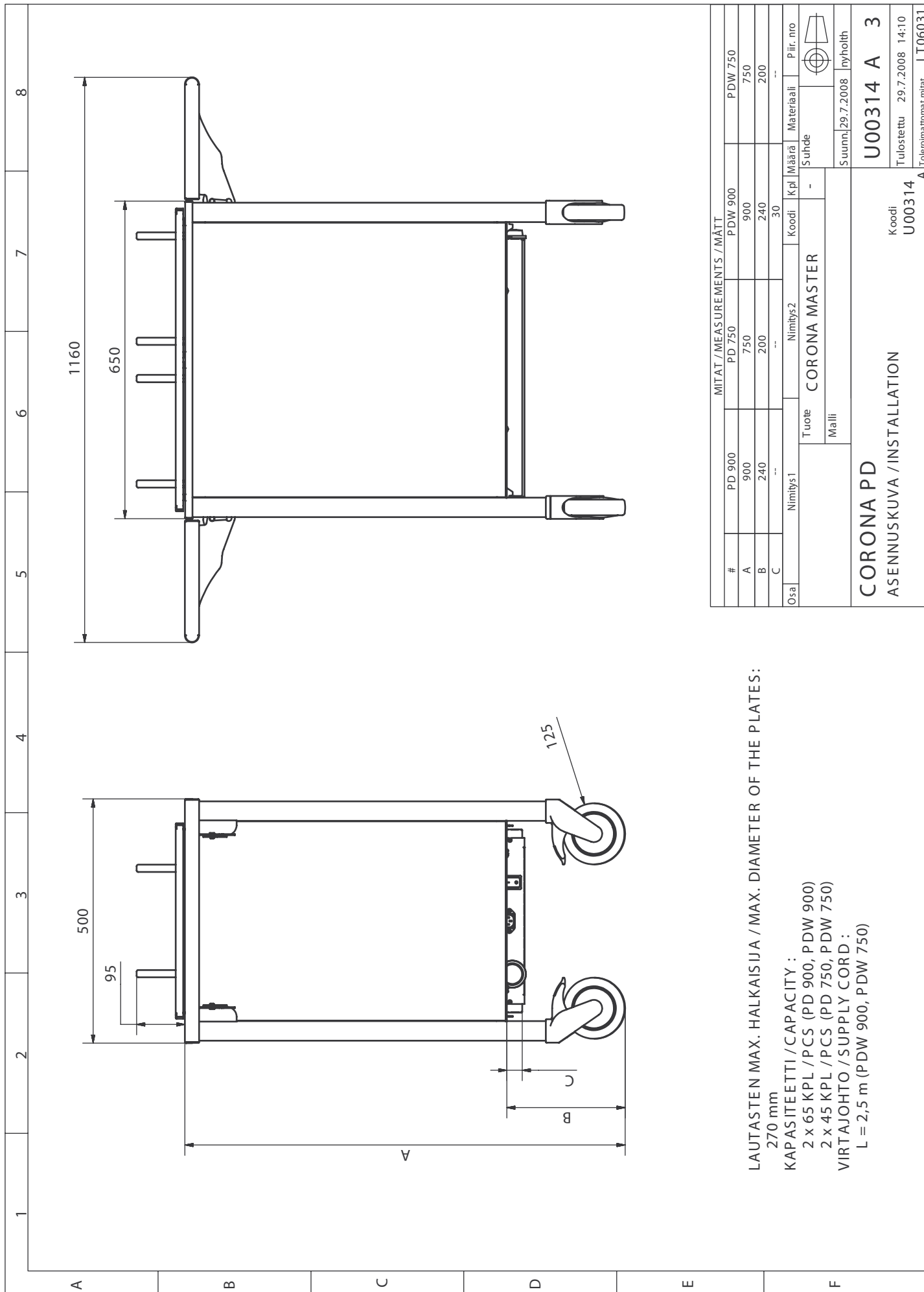

## Technical specifications

---

Item	Model	Specification
Electrical connection		230V 50Hz
Power input	CB,CBUS	0,43 kW
Power input	BM,BMUS	1,8 kW
Power input	N	18/30 W
Power input	PDW	0,7 kW
Refrigerant	CB,CBUS	R134a
Insulation material	CB,CBUS	Foamed polystyrene
Control unit	CB,CBUS	Thermostat
Temperature range	BM,BMUS	60...90°C
Temperature adjustment	BM,BMUS,PDW	Thermostat
Standard colours, cover plates, wood		Koski melam. Birch
		Grey tiwi melam. 802 matt
		Koski melam. Cherry smooth
Standard colours, cover plates, steel		Red RAL 3000
		Blue RAL 5005

CB=REFRIGERATED CB, CBUS=REFRIGERATED UNIT WITH UPPER SECTION CBUS, BM=BAIN-MARIE BM, BMUS=BAIN-MARIE WITH UPPER SECTION BMUS, SB=NEUTRAL SB, N=NEUTRAL UNIT WITH UPPER SECTION N, PDW=HEATED PLATE DISPENSER PDW, PD=NEUTRAL PLATE DISPENSER PD

800=Length 800 mm, 1200=Length 1200 mm

Valmistajan nimi / Tillverkarens namn / Manufacturer's name

**METOS OY AB**

Osoite / Adress / Address

04220 KERAVA  
FINLAND

Vakuuttaa, että seuraava tuote / Försäkrar att följande produkt / Declare that the following product

Nimi, tyyppi tai malli / Namn, typ eller modell / Name, type or model

**Drop-in** kylmä- ja lämminlaitteet / varm och kall enheter / heated and cold units  
Drop-in tekniikkaan perustuvat **Nova ja Corona** yksiköt / **Nova och Corona** enheter som byggs av  
drop-in teknik / **Nova and Corona** units based on drop-in technology

on seuraavien direktiivien asiaankuuluvien säännösten mukainen / överensstämmer med tillämpliga bestämmelser  
i följande direktiv / is in conformity with the relevant provisions of the following directives

MD 2006/95/EC, LVD 2006/95/EC, EMC 2004/108/EC, RoHS 2002/95/EC, WEEE 2002/96/EC

ja lisäksi vakuuttaa, että seuraavia yhdenmukaistettuja standardeja (tai niiden osia/kohtia) on sovellettu / och  
försäkrar dessutom att följande harmoniserade standarder (eller delar/paragrafer) har använts / and furthermore  
declares that the following harmonised standards (or parts/clauses) have been used

SFS-EN 61000-6-3: 2002  
SFS-EN 61000-6-1: 2002  
SFS-EN ISO 12100-1: 2003  
SFS-EN ISO 12100-2: 2003

ja lisäksi vakuuttaa, että seuraavia muita standardeja (tai niiden osia/kohtia) on sovellettu / och försäkrar dessutom  
att följande andra standarder (eller delar/paragrafer) har använts / and furthermore we declare that the following  
other standards (or parts/clauses) have been used

SFS-EN 60335-1: 2002  
SFS-EN 60204-1: 2006

Tuotteen suunnitelmatarkastustodistus ja laatujärjestelmää valvova ilmoitettu laitos (vain painelaitteet)  
Produktens konstruktionskontrollcertifikat och anmält organ, som övervakar kvalitetssystemet (endast tryckkärl)  
Product design examination certificate and the notified body supervising the quality system (only pressure vessels)

Alla mainittu henkilö on valtuutettu kokoamaan teknisen tiedoston / Nedan nämnda person är bemyndigad att  
sammanställa den tekniska dokumentfilen / The person mentioned below is authorized to compile the technical file

Antti Myllys Metos Oy Ab, Ahjonkaarre, 04220 Kerava, Finland

Antopaikka ja päivä / Utfärdad på ort och datum / Place and date of issue

KERAVA 15.6.2010

Valtuutetun henkilön nimi ja asema / Bemyndigad persons namn och befattning / Name and title of authorized person

  
Pekka Mönkkönen – Director of Business Unit

  
Jani Paatola - Manager