

metos

COMBI-KETTLE

PROVENO S

TYPE: 40 l, 60 l, 80 l, 100 l, 150 l, 200 l, 300 l, 400 l

Accessories
COMBI PRO
COOL
COOL PRO

Installation and Operation Manual



S/N: 10911002080010

Valid from: 08. 02. 2010

Rev.: 4.2

Combi Pro S 4222065, 4222066, 4222067, 4222068, 4222069, 4222070, 4222071, 4215833
Cool S 4222079, 4222080, 4222081, 4222082, 4222083, 4222136, 4222084, 4215834
Cool Pro S 4222092, 4222093, 4222094, 4222095, 4222096, 4222097, 4222098, 4215835

Dear Customer,

Congratulations on deciding to choose a Metos appliance for your kitchen activities. You made an excellent choice. We will do our best to make you a satisfied Metos customer like thousands of customers we have around the world.

Please read this manual carefully. You will learn correct, safe and efficient working methods in order to get the best possible benefit from the appliance. The instructions and hints in this manual will give you a quick and easy start, and you will soon note how nice it is to use the Metos equipment.

All rights are reserved for technical changes.

You will find the main technical data on the rating plate fixed to the equipment. When you need service or technical help, please let us know the serial number shown on the rating plate. This will make it easier to provide you with correct service.

For your convenience, space is provided below for you to record contact information for your local service provider.

METOS TEAM

Phone number of your service provider:.....

Contact person:.....

1. General	1
1.1 Symbols used in the manual	1
1.2 Symbols used on the appliance	1
1.3 Checking the relationship of the appliance and the manual	1
1.3.1 Proveno combi-kettle versions	2
2. Safety instructions	6
2.1 General	6
2.2 Construction of the combi-kettle	7
2.3 Safe and correct use	10
2.3.1 Avoiding burns	10
2.3.2 Avoiding risks during mixing and tilting the kettle	10
2.3.3 Other instructions for correct and safe use	11
2.3.4 Changing the settings and adjustments	12
2.3.5 Safety instructions in the event of malfunction	12
2.4 Disposal of the appliance	12
2.5 Other prohibitions (dangerous methods and procedures)	12
3. Functional description	13
3.1 Intended use of the appliance	13
3.1.1 Use for other purposes	13
3.2 Construction	13
3.3 Operating principle	13
3.4 Operation switches and indicator lights	13
3.4.1 Display messages for the user	16
3.4.2 Error message lights	16
4. Operation instructions	17
4.1 Before use	17
4.1.1 Preparing the use	17
4.2 Operation procedures	19
4.2.1 Operating the control panel - General	19
4.2.2 Tilting the kettle	19
4.2.3 Positioning the mixing tool and scrapers	20
4.2.4 Cooking	21
4.2.5 Changing the temperature	22
4.2.6 Stopping the cooking	22
4.2.7 Mixing functions	22
4.2.8 Mixing while tilting (R option)	24
4.2.9 Water automation	24

4.2.10	Timer functions	25
4.2.11	Automatic cooling	27
4.2.12	Manual cooling (option)	29
4.2.13	EasyRun programming	30
4.2.14	Possible power failure during timing or EasyRun program	31
4.2.15	Self-control (HACCP) (option)	32
4.3	After use	32
4.3.1	Cleaning	32
4.3.2	Periodic service	35
4.3.3	Service recording	35
5.	Installation	36
5.1	General	36
5.1.1	Operating conditions	36
5.1.2	Possible interference from the surroundings (to the surroundings)	36
5.1.3	Storage	36
5.1.4	Unpacking the appliance	37
5.1.5	Disposal of the package	37
5.2	Installation	37
5.2.1	Subsurface frame cast into the floor	38
5.2.2	Surface installation frame fixed to the floor	39
5.2.3	Installing the combi-kettle on the frame	40
5.3	Electrical connections	44
5.4	Water connections	47
5.4.1	Icebank connections (C3 option)	47
5.4.2	Water connection and quality requirements	47
5.4.3	Extreme water conditions	48
5.5	Steam and condensate connections	48
5.6	Ventilation	49
5.7	Other installations	49
5.8	Procedures after installation	49
5.8.1	Adjusting the tilting	49
5.8.2	Fastening the mixer motor cover box	50
5.9	First run and testing	50
5.9.1	Switching the kettle on	50
5.9.2	Checking the safety block	51
5.10	Adjustments, programming	51
5.11	Staff training	51
5.12	Combination of machines	51

6. Adjustment instructions	52
6.1 Setting customer specific parameters	52
6.2 Customer specific parameters, settings and factory presets	53
7. Troubleshooting	55
8. Technical specifications	59

1. General

Carefully read the instructions in this manual as they contain important information regarding proper, efficient and safe installation, use and maintenance of the appliance.

Keep this manual in a safe place for eventual use by other operators of the appliance.

The installation of this appliance must be carried out in accordance with the manufacturer's instructions and following local regulations. The connection of the appliance to the electric and water supply must be carried out by qualified persons only.

Persons using this appliance should be specifically trained in its operation.

Switch off the appliance in case of failure or malfunction. The periodical function checks requested in the manual must be carried out according to the instructions. Have the appliance serviced by a technically qualified person authorized by the manufacturer and using original spare parts.

Not complying with the above may put the safety of the appliance in danger.

1.1 Symbols used in the manual



This symbol informs about a situation where a safety risk might be at hand. Given instructions are mandatory in order to prevent injury.



This symbol informs about the right way to perform in order to prevent bad results, appliance damage or hazardous situations.



This symbol informs about recommendations and hints that help to get the best performance out of the appliance.

1.2 Symbols used on the appliance



This symbol on a part informs about electrical terminals behind the part. The removal of the part must be carried out by qualified persons only.

1.3 Checking the relationship of the appliance and the manual

The rating plate of the appliance indicates the serial number of the appliance. If the manuals are missing, it is possible to order new ones from the manufacturer or the local representative. When ordering new manuals it is essential to quote the serial number shown on the rating plate.

If language versions have information contradictions, the original language Finnish is the primary language regarding the information content.

1.3.1 Proveno combi-kettle versions

The user panel and the available functions on the combi-kettle are different depending on the combi-kettle version. This manual covers the Proveno Combi Pro, Combi Pro + EasyRun, Cool and Cool Pro versions.

The functions of the different versions are:

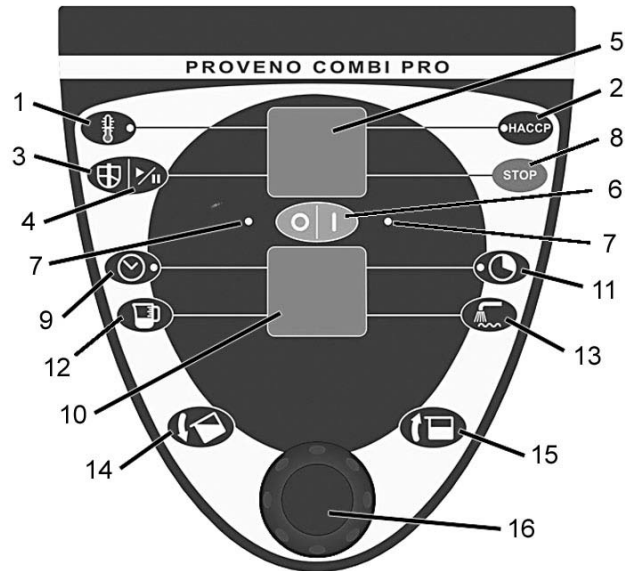

Proveno Combi Pro

1. Heating
2. HACCP
3. Mixer
4. Mixer start and pause
5. Displays for heating and mixer
6. ON/OFF switch
7. Error message lights
8. Stop (to stop the mixer)
9. Starting time
10. Displays for timer and water fill
11. Function time
12. Automatic water fill
13. Manual water fill
14. Kettle bowl tilting
15. Return kettle bowl to upright position
16. Central dial

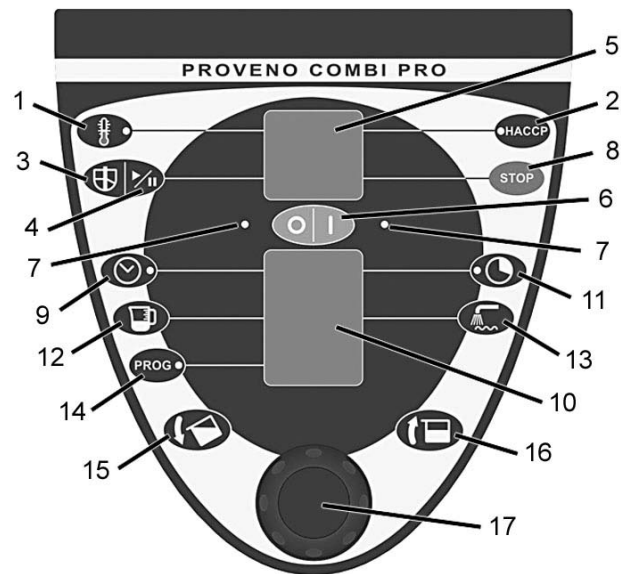

Proveno Combi Pro + EasyRun

1. Heating
2. HACCP
3. Mixer
4. Mixer start and pause
5. Displays for heating and mixer
6. ON/OFF switch
7. Error message lights
8. Stop (to stop the mixer)
9. Starting time
10. Displays for timer, water fill, EasyRun programming and cooling
11. Function time
12. Automatic water fill
13. Manual water fill
14. EasyRun program
15. Kettle bowl tilting
16. Return kettle bowl to upright position
17. Central dial

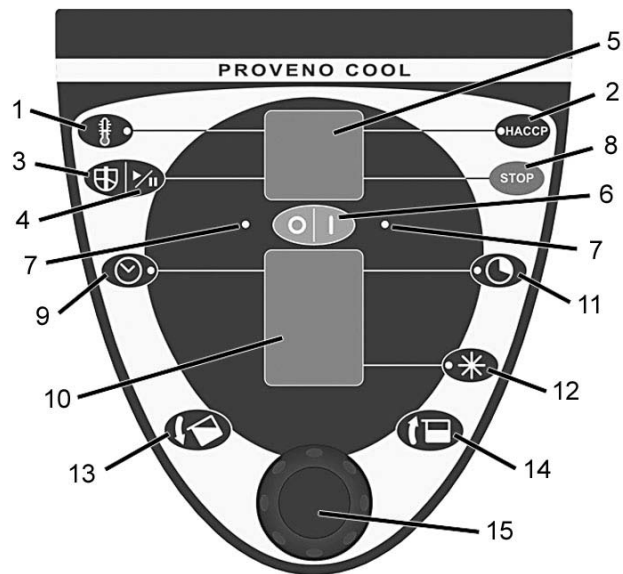

Proveno Cool

1. Heating
2. HACCP
3. Mixer
4. Mixer start and pause
5. Displays for heating and mixer
6. ON/OFF switch
7. Error message lights
8. Stop (to stop the mixer)
9. Starting time
10. Displays for timer and cooling
11. Function time
12. Automatic cooling
13. Kettle bowl tilting
14. Return kettle bowl to upright position
15. Central dial

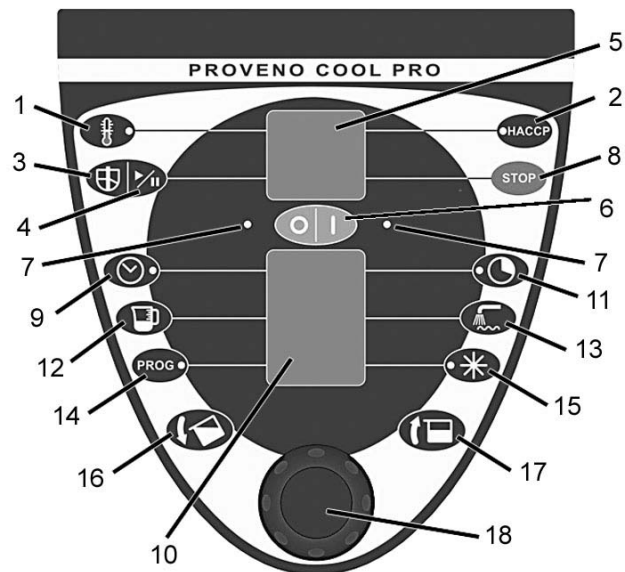

Proveno Cool Pro

1. Heating
2. HACCP
3. Mixer
4. Mixer start and pause
5. Displays for heating and mixer
6. ON/OFF switch
7. Error message lights
8. Stop (to stop the mixer)
9. Starting time
10. Displays for timer, water fill, EasyRun programming and cooling
11. Function time
12. Automatic water fill
13. Manual water fill
14. EasyRun program
15. Automatic cooling
16. Kettle bowl tilting
17. Return kettle bowl to upright position
18. Central dial

2. Safety instructions

2.1 General

The Proveno combi-kettle has been designed and manufactured in compliance with the Directive regarding Safety of Machinery, the Low Voltage Directive, the Directive regarding Electromagnetic Compatibility and the Directive regarding Pressure Equipment currently in force.

The Proveno combi-kettle is a pressurized vessel with a maximum operating pressure of 1 bar (or 0,5 bar for certain markets). Overpressure is prevented by means of both mechanical (safety valve, pressure switch) and electronic control.

Heating, mixing, water filling or cooling do not function when the kettle is tilted. All functions of the kettle are interrupted when the emergency/stop switch is pressed. The switch is released by turning it to the right.

The manufacturer does not take responsibility for consequences caused by incorrect use or use against the operation instructions.

2.2 Construction of the combi-kettle

The main parts of the combi-kettle are illustrated in the following pictures:

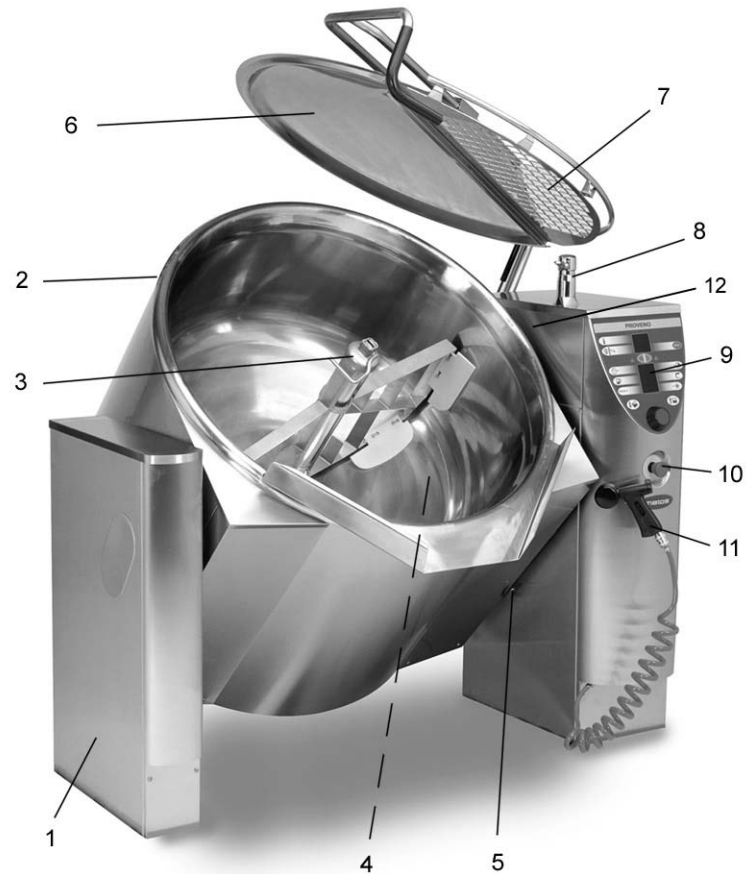

1. Support pillar
2. Safety block
3. Mixer and mixing tool (accessory)
4. Strainer plate (accessory)
5. Emptying valve for steam generator
6. Safety lid
7. Safety grid for fill opening
8. One-grip tap for cleaning jet
9. Control panel
10. Emergency/stop button
11. Cleaning jet
12. Water fill to kettle

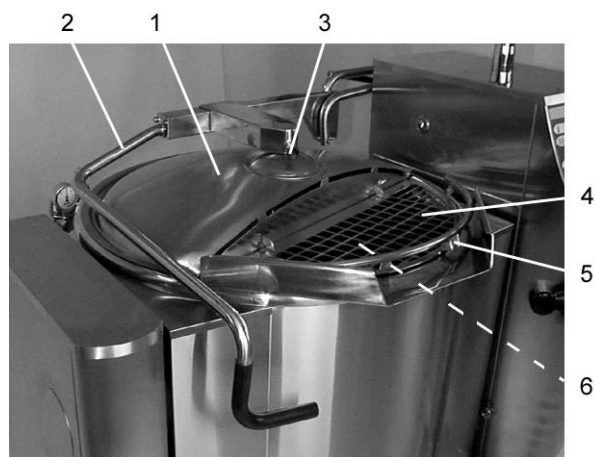

Lid

1. Safety lid
2. Lifting arm
3. Locking lever of the lid
4. Safety grid for fill opening
5. Safety switch
6. Cover for fill opening

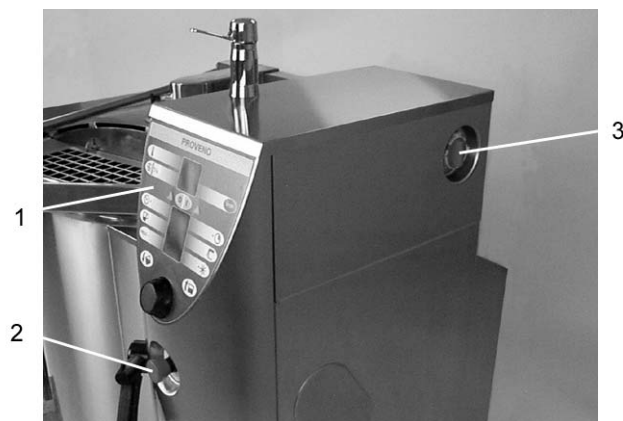

Control panel and mains switch

1. Control panel
2. Emergency/stop button
3. Mains switch

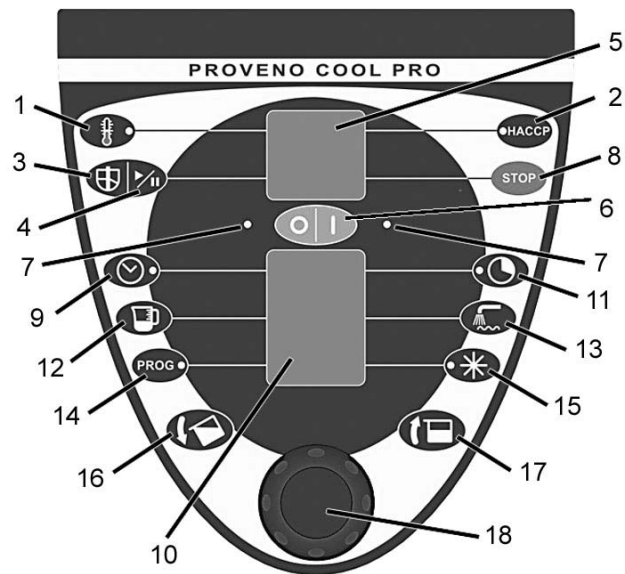

Proveno Cool Pro

1. Heating
2. HACCP
3. Mixer
4. Mixer start and pause
5. Displays for heating and mixer
6. ON/OFF switch
7. Error message lights
8. Stop (to stop the mixer)
9. Starting time
10. Displays for timer, water fill, EasyRun programming and cooling
11. Function time
12. Automatic water fill
13. Manual water fill
14. EasyRun program
15. Automatic cooling
16. Kettle bowl tilting
17. Return kettle bowl to upright position
18. Central dial

2.3 Safe and correct use

Use of the combi-kettle is prohibited if you have not acquainted yourself with the user manual and the safety instructions it contains. Observe the following instructions concerning safe and correct use of the appliance. In case of malfunction, proceed as follows:



- Check the nature of malfunction to be able to describe it and the situation where it occurs. Also consult the user manual to make sure that the appliance really functions against the operation instructions.
- Review the troubleshooting table contained in this manual to find a possible cause and repair measures.
- Contact your service provider. Be ready to quote the data for easy identification of the appliance (service code, manufacturing number, model, type, year of purchase etc.) and to describe the problem as accurately as possible.

The manufacturer does not take responsibility for any damage in case the operation instructions and warnings contained in this manual are neglected.

2.3.1 Avoiding burns



- Beware of the inner surface, the upper rim and the lid that may be hot.
- Beware of hot steam when opening the lid.
- Beware of the hot mixing tool after cooking. Use protective gloves.
- Do not open the bottom valve or the emptying valve of the steam generator when the kettle is hot (pressurized).
- Always make sure that the mixing speed is appropriate, thus preventing foodstuffs from splashing up through the holes of the lid.
- Keep the emptying valve of the steam generator closed. Open it only when there is no pressure, i.e. when you plan to empty the steam generator entirely or to remove the cooling water.
- Beware of hot steam and hot surfaces when you add ingredients to the kettle or taste the food you are preparing.
- When cooling the food, water discharging from the steam generator may be hot at the beginning of the process.

2.3.2 Avoiding risks during mixing and tilting the kettle

- Stop the mixer before opening the lid either with the  or  button.
- Do not push your fingers or utensils into the kettle when the mixer is in operation.
- Do not wear scarfs, ties etc. hanging clothing which may catch on the rotating mixer.
- Protect your hair to prevent it from catching on the rotating mixer.
- Do not touch the rotating mixer.
- Operating the mixer when the lid is open is prevented/prohibited under all circumstances (safety regulations at work).
- Ensure that nobody stands behind or in front of the kettle during tilting.
- Do not stand in front of the kettle when you tilt the kettle or reverse it to a horizontal position.

- When tilting the kettle, make sure there are no objects in the space between the kettle and the pillars or that no objects can fall there when the kettle is being tilted.
- When tilting the kettle, make sure that nobody's fingers, hands or other parts of their body are in danger of getting between the kettle and the pillars.
- Always check that the mixing tool has been locked in place before starting to mix.
- Always check that the scrapers have been properly attached to the mixing tool.

2.3.3 Other instructions for correct and safe use

- Stop the mixer before opening the lid either with the  or  button. Stopping the mixer by opening the lid activates the emergency/stop function.
- Keep the cleaning jet tap closed when the jet is not used.
- The mixing tool is easier to position and remove from the kettle when the kettle is in a tilted position (ergonomics).
- Protect yourself in an appropriate way when cleaning the kettle (follow safety and handling instructions of the detergent).
- Do not use the kettle if its protective/cover plates are not properly in place.
- Observe the cleaning instructions. Avoid excessive use of water when cleaning the control pillar. **Use of a high-pressure jet is prohibited.** Disconnect the control voltage of the kettle with the ON/OFF switch and with the mains switch before cleaning the kettle.



1. ON/OFF switch
2. Mains switch

- Make sure before use that the removable lid is properly in place.
- Make sure before use that the safety grid is properly in place.
- Always open the lid to its extreme position and check the lid's secure before you bend down over the kettle.
- Check the kettle's safety valve at regular intervals in the way explained in this manual, and keep a record of regular checks.

2.3.4 Changing the settings and adjustments

Only qualified persons with sufficient competence and expert knowledge of the appliance are allowed to change technical adjustments. The user can adjust some functions of the appliance to make them better suit their food production (see "Setting customer specific parameters"). The service parameters can only be adjusted by a qualified person having the required expert knowledge of the appliance.

2.3.5 Safety instructions in the event of malfunction

In case of a serious emergency, all functions of the appliance must be stopped by pressing the emergency/stop button or by turning the mains switch to the OFF position. The functions become operable when the button is released by turning it to the right. In case the reason for using the emergency/stop switch is a serious malfunction jeopardizing safety at work, contact an authorized service provider immediately.

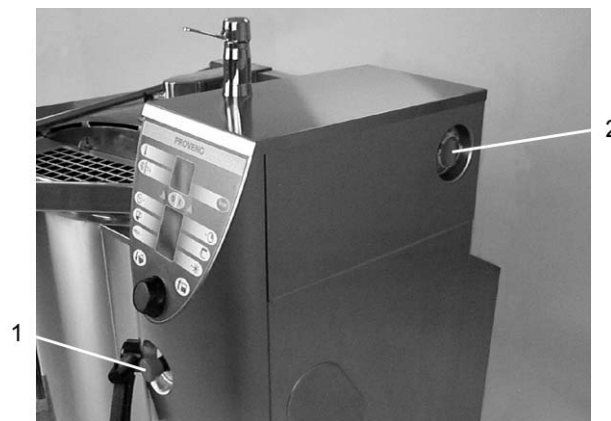

1. Emergency/stop button
2. Mains switch

2.4 Disposal of the appliance

When the appliance has reached the end of its useful life, it must be disposed of in compliance with the local rules and regulations. The best way of dealing with or recycling any substances which potentially have an adverse impact on the environment is to dispose of them through a proper waste company.

2.5 Other prohibitions (dangerous methods and procedures)

Deliberate disregard of safety devices is prohibited, as it jeopardizes safe work in the kitchen. The manufacturer does not take responsibility for damage caused by deliberate use of a defective appliance, disregard of the safety precautions by modifying the designed operation of the appliance, or neglect of the technical condition, maintenance or service of the appliance.

3. Functional description

3.1 Intended use of the appliance

The Proveno combi-kettle is designed for professional food preparation. Using Proveno for other purposes is prohibited. It is forbidden to put corrosive ingredients or substances reacting with each other in the kettle. Please observe that long-term effect of some substances used in food preparation is corrosive. Such substances are, for example, salt, acetic acid, citric acid and lactic acid.

3.1.1 Use for other purposes

The manufacturer does not take responsibility for functional troubles or damages caused by misuse or use for other purposes than stated above.

3.2 Construction

The construction of the kettle is of stainless steel throughout (AISI 304). The inner bottom and jacket are of acid-proof steel (AISI 316). The kettle is triple-jacketed and thermally insulated throughout.

3.3 Operating principle

The Proveno kettle is heated with direct steam provided from the facility's steam network.

The kettle tilts by means of a tilting motor (40-150-litre kettles). Larger kettles (200-400 litres) are equipped with a hydraulic tilting mechanism. The mixing functions (accessory) are performed by means of a gear motor. Cooling (accessory) is based on cold water circulating inside the kettle's steam jacket. The control panel of the appliance is situated on the kettle's right-hand pillar (control pillar).

3.4 Operation switches and indicator lights

All Proveno's operation switches, except for the central dial, are push buttons. The buttons are activated by a light and gentle push or by holding a button down for some time (2-10 seconds), depending on what function you plan to use. Values to be set are selected by means of an auto-reverse central dial. Turning clockwise (to the right) increases and turning anticlockwise (to the left) decreases the value being selected. If a button is fitted with an indicator light, it shows if a function is on or if it has been programmed to start later. The buttons and displays related to various functions as well as the functions of the buttons are illustrated in the following pictures:

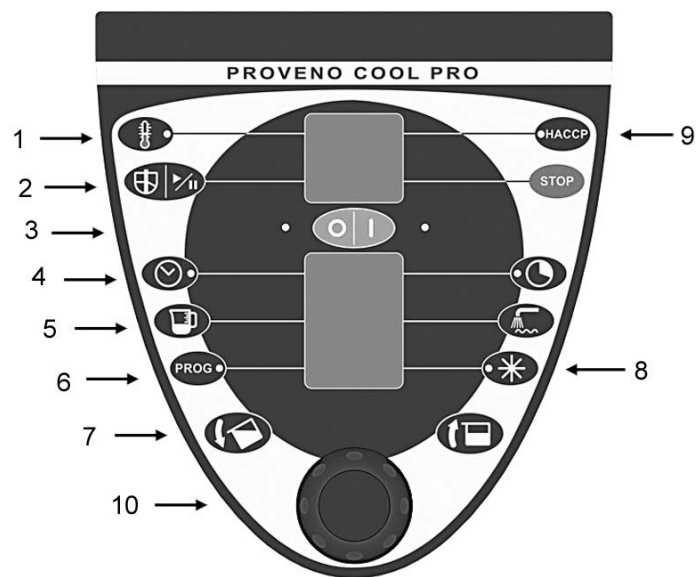

1. Heating function
2. Mixing function
3. ON/OFF and error message lights
4. Timer functions
5. Water fill functions
6. EasyRun programming function
7. Tilting function
8. Cooling function
9. HACCP
10. Central dial

Functional description

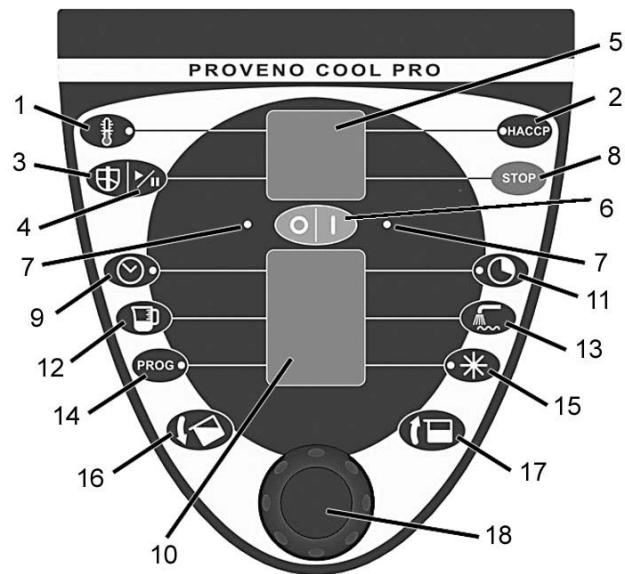

Proveno Cool Pro

1. Heating
2. HACCP
3. Mixer
4. Mixer start and pause
5. Displays for heating and mixer
6. ON/OFF switch
7. Error message lights
8. Stop (to stop the mixer)
9. Starting time
10. Displays for timer, water fill, EasyRun programming and cooling
11. Function time
12. Automatic water fill
13. Manual water fill
14. EasyRun program
15. Automatic cooling
16. Kettle bowl tilting
17. Return kettle bowl to upright position
18. Central dial

Functional description

3.4.1 Display messages for the user

- Blinking number/letter in various fields of the display in general: the appliance is waiting for a value to be set with the central dial (approx. 3 seconds).
- Blinking 'PoS' on the temperature display: the kettle is not in the cooking position (completely upright and horizontal). E.g. heating and mixing functions, water automation and cooling function cannot be operated.
- Blinking 'Lid' on the mixer display: the lid is open, mixing is not possible (safety regulations) or the lid is closed when you try to tilt the kettle.
- 'Err' in the water automation function: the appliance does not get water.
- Blinking 'SEt' in the cooling function reminds you to start the mixer to make cooling more efficient.

3.4.2 Error message lights

There are two red indicator lights on the control panel to indicate an error or malfunction.



1. Indicator light 1
2. Indicator light 2

Error/malfunction	Indicator light 1	Indicator light 2
Defective solenoid switch of the safety grid or the safety grid is on the kettle and the lid's lifting arm is in an upper position. Remove the safety grid and press the STOP button.	blinking	blinking
Automatic water filling pulses missing		illuminates
Timing not succeeded (long power failure)	illuminates	
Mixing motor overheated	illuminates	blinking
Malfunction of external cooling equipment	blinking	illuminates
Defect in temperature adjustment (+124°C exceeded)	blinking (by turns)	blinking (by turns)

4. Operation instructions

4.1 Before use

4.1.1 Preparing the use

Daily check before use

- Water supply (hot/cold) is open.
- No inappropriate objects in the kettle.
- Scrapers are correctly attached to the mixing tool. See "Positioning the mixing tool and scraper".
- The mixing tool has been locked in its place: locking part (one end of the handle) in the groove of the mixer axle, with the handle turned in a horizontal position. Secure fixing by trying to lift the tool out of the kettle by the upper blade.

Quarterly check (safety valve)

It is the responsibility of the user to check the safety block of the combi-kettle **four** times a year. Ask a qualified person to carry out the check as follows:

- Open the safety valve while the kettle is pressurized by lifting the safety valve lever.
- When the steam is discharging (sound, pressure gauge reading reduces), allow the lever to return to the lower position.



Beware of hot steam discharging from the safety valve!

Operation instructions

Maintenance information

Combi-kettle _____ Serial No. _____ Taken into use (date) _____

Quarterly safety valve check performed

Date	By	Remarks	Date	By	Remarks

Yearly maintenance performed

Date	By	Remarks	Date	By	Remarks

Descaling performed

Date	By	Remarks	Date	By	Remarks

4.2 Operation procedures

4.2.1 Operating the control panel - General

When the appliance is started with the ON/OFF switch, all displays and indicator lights on the control panel illuminate for a short time (display test). After that, 'On' remains on the temperature display and the time on the timer display (if the kettle is fitted with a timer function). The appliance is now ready for use.

The same logic is repeated in all button functions of the control panel.

Selecting/activating a function:

Press briefly the appropriate button and then set the value desired using the central dial, for example:



The appliance waits for the value for three seconds (the selected display is blinking), whereafter the appliance starts to perform the function according to the set value. In some functions, e.g. in automatic water fill, a second press is still needed to confirm and activate the function before the function starts to operate.

Stopping/cancelling a function:

Press the appropriate button for a long time (approx. 2 seconds).

4.2.2 Tilting the kettle

It is not possible to tilt the kettle when the lid is closed. In case you try to tilt the kettle with the lid in a closed position, a blinking 'Lid' message appears on the display.



Tilting the Proveno kettle is carried out by pressing the tilting button.

The kettle tilts as long as the button is held down. In case the "pull-back" function is on, (see "Adjustment instructions, Setting customer specific parameters"), a slight reversing movement occurs after the button is released, which decreases dripping of food from the the spout.

In case the kettle is tilted to its extreme position, the reversing movement making the kettle completely empty does not occur.



Tilting the kettle to the cooking position is carried out by pressing the upright position button.

For safety reasons (safety regulations), the reversing movement lasts only as long as the button is pressed. The upright position button must be pressed so long that the reversing movement stops and the kettle is in the cooking position. In case the kettle is not reversed up to the cooking position, a blinking 'PoS' message appears on the display when you try to switch the heating or mixing on.

Operation instructions

4.2.3 Positioning the mixing tool and scrapers

Attach the scrapers by placing the pins on the mixing tool into the holes on the scrapers. After that turn the scraper into place by lifting the scraper's lower part. Finally pull the scraper forward. The bevel (1) will on the lower scraper point upwards and on the side scraper away from the mixer axle.

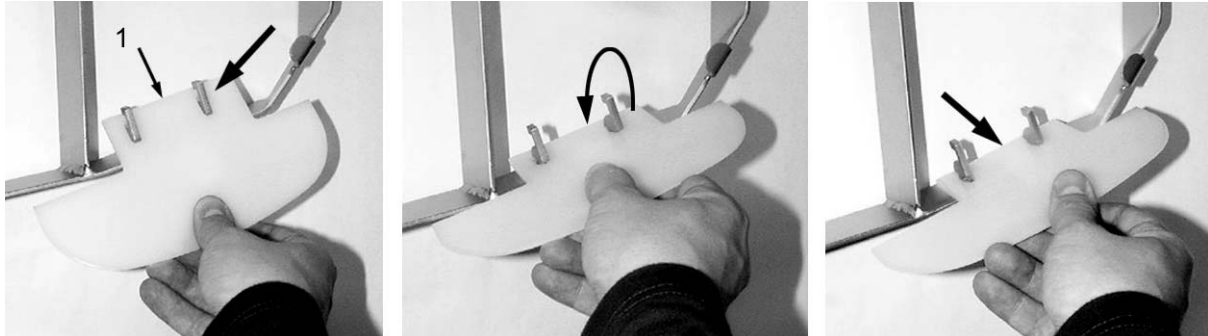

The mixing tool is equipped with 1-5 scrapers, depending on the size of the tool.

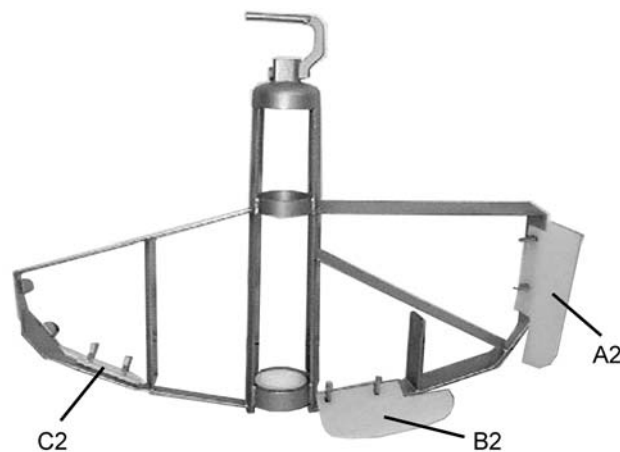

Scraper	40	60	80	100	150	200	300	400
Scraper A2	-	1	1	2	1	2	1	2
Scraper B2 (bottom)	-	-	1	1	1	1	1	1
Scraper C2 (bottom)	1	1	-	-	1	1	2	2

Scrapers are not needed when preparing large quantities of mashed potatoes or when kneading dough. Use scrapers in all other cooking modes to increase the efficiency of heat transfer and to help the cleaning of the kettle.

It is easiest to attach the mixing tool to the mixer axle when the kettle is in a tilted position. Push the ring on the mixing tool into the kettle's mixer axle and fit the mixing tool in place, while the lifting handle is straight so that the locking device of the lifting handle sets in the groove at the upper end of the mixer axle.



Then turn the handle aside.

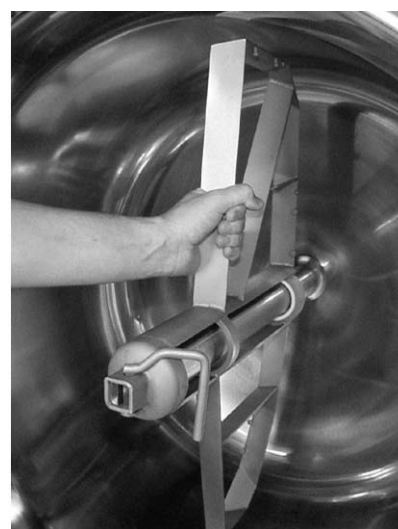

Make sure that the mixing tool is locked in its place by trying to lift/pull it out of its place by pulling at the mixer blade, for example.

4.2.4 Cooking



Switch on the appliance. 'On' appears on the temperature display.



Press the temperature button once.



Select temperature with the central dial.

When the temperature starts to blink on the display, you can select the desired temperature using the central dial. The set value is automatically saved in the memory after about three seconds, temperature blinking stops on the display and the kettle starts to heat. If you did

Operation instructions

not manage to set the temperature while the temperature display was blinking, press the temperature button again and select the desired temperature with the central dial.



Temperature setting and temperatures displayed:

0 - 50°C	kettle inner surface temperature on the display
51 - 100°C	food temperature on the display
101 - 120°C	steam jacket temperature on the display



Heating is only switched on when the kettle is in an upright position (cooking position). If the heating function is selected when the kettle is not in an upright position, the message 'PoS' appears on the display indicating that the heating will not switch on because the kettle is not in the cooking position. Open the lid and revert the kettle to the cooking position.

4.2.5 Changing the temperature



Press the temperature button.



Select the temperature desired.

4.2.6 Stopping the cooking



Press the temperature button for a long time (approx. 2 seconds).

The heating goes off when 'On' appears on the display.

4.2.7 Mixing functions

Starting the mixer (manual mixing)



Switch on the appliance. The temperature display indicates 'On'.



Select the mixing function. Message '15' appears on the mixer display.



Start the mixer.

You can adjust the mixing speed with the central dial while the mixer display is blinking.

Changing the speed



When the mixer is running, press the start/pause button once.



Select the speed (15-140 rev./min.) with the central dial.

NOTE: You cannot change the mixing speed, if a mixing program (P1-P6) is in operation. However, it is also possible to start power mixing when a mixing programs is running (see "Power mixing during mixing").

Auto-reverse function



When the mixer is running, press the mixer button once. A rotating symbol appears on the left-hand side of the display and the mixer is auto-reversing.

Power mixing during mixing



When the mixer is running, press and keep pressed the mixer button. A rotating symbol appears on the whole display.

Power mixing is heavy auto-reverse mixing, which continues as long as the button is held down. Power mixing can be used whenever the mixer is running, also during the pre-set mixing programs.



Make sure before using power mixing that possible splashes of food do not cause any danger to safety at work.

Pre-set mixing programs (P1 - P6)



Select the mixing function. Message '15' appears on the mixing display



Select the desired mixing program P1 - P6.



Start the mixing program.

The display shows the number and phase of the program in operation (e.g. P2.2). The pre-set programs are as follows:

P1	Gentle stirring with pause, soups - total time: continuous, max. 5 hours
P2	Meat cooking, powerful auto-reverse mixing - total time: 44 min., whereof 6 min. crumbling
P3	Mashed potatoes, powerful auto-reverse mixing - total time: 13 min. whereof 6 min. mashing
P4	Desserts - total time: 1 hour 20 min., whereof last 40 min. whipping
P5	Porridges - total time: 1 hour 40 min.
P6	Doughs - total time: 6 min.

Interrupting/continuing the mixer program



Press the start/pause button once.



The mixer stops according to the instructions also when the lid is opened. The correct way to stop the mixer is to press the stop or start/pause button:



Opening the lid activates the emergency/stop function.

Stopping the mixer program



Press the stop button once.



The mixer stops according to the instructions also if the lid is opened. The correct way to stop the mixer is to press the stop or start/pause button:





Opening the lid activates the emergency/stop function.

4.2.8 Mixing while tilting (R option)

This option enables forced mixing at the lowest mixing speed while the kettle is tilted. With the help of this function it is possible to portion more homogenous batches of food into smaller bowls.

For safety reasons, the mixer only operates at the lowest speed of 15 rev./min. The metal button for forced mixing located above the emergency/stop button must be held down.

Do as follows:

- Lift the kettle lid to an upper position.
- Press the metal button for forced mixing and keep it pressed all the time.
- Using a finger of your other hand, press the mixing function button 
- Press the mixer start button 

=> The mixer starts to run at a speed of 15 rev./min. It is not possible to raise the speed.

- Continue to keep the metal button for forced mixing pressed.
- Press the tilting button  with a finger of your other hand.

=> The kettle tilts and the mixer runs all the time at a speed of 15 rev./min.

Release the metal button for forced mixing when you want to stop this function. To operate mixing functions after that, close the lid and put the safety grid on the kettle according to instructions.

4.2.9 Water automation

Manual water fill



Press and keep pressed.

Cold water flows into the kettle as long as the button is held down. The display shows all the time the amount of water in litres. The display goes off and sets to zero soon after the water fill is completed.



In case water supply to the appliance is prevented, the display shows an error message 'Err'. Check that the water supply closing valve is open.

Automatic water fill



Press once.



Select the amount to be filled.



Start filling by pressing once again.

The selected amount of cold water flows automatically into the kettle. The display shows all the time the amount in litres poured into the kettle.

Stopping/cancelling the automatic water fill



Interrupt water fill by pressing once.

Water flow will immediately stop. The amount of water filled is shown on the display for 10 seconds. The display goes off to indicate that the function has been cancelled/stopped.

Changing the amount of automatic water fill during filling



Interrupt the function by pressing once. The display shows the selected amount in litres.



Select the new amount to be filled within 10 seconds. You can select the amount to be filled between the filled amount and the kettle's net volume.



Continue filling by pressing once.

When the automatic water fill is completed, the filled amount is shown on the display for 10 seconds, after which the display goes off. The filled amount is saved in the memory until the kettle's control voltage is cut, and it can be displayed by pressing the automatic water fill button once.

4.2.10 Timer functions

Setting the time

Setting correct time by the clock is necessary to make timing and data collection possible.



Press and simultaneously hold down for about 2 seconds.



Set the time.

Start selecting the time within three seconds after the timer display begins to blink. When you have set the time, it will be saved automatically in the memory after about three seconds, and the timer starts up.

Setting the date

Setting the correct date is necessary to make the data collection possible.



Press and simultaneously keep pressed.

In about 2 seconds, the timer display starts blinking.

Continue holding the button down until 'Yr' blinks on the timer display and two last digits of the year illuminate. Release the buttons.



If needed, select a new year within 3 seconds.

After the year is locked, 'Mo' and a month begin to blink on the timer display.



If needed, select a new month within 3 seconds.

After the month is locked, 'dY' and a day of the week begins to blink on the timer display.



If needed, select a new day within 3 seconds.

After the day is locked, the timer display begins to show the actual time.

Activating the starting time and duration of cooking



Press once.

Proveno suggests the cooking temperature, starting time and duration that you used the previous time. If you do not want to change the values, the functions are activated automatically in about 15 seconds. Cooking begins at the selected time and Proveno cooks at the set temperature for the set period of time. Counting the cooking time does not begin until the set temperature has been reached. Proveno is equipped with an **automatic hold-function** (factory setting +70°C). You can change the holding temperature between +50 - +100°C (see "Setting customer specific parameters").

After the cooking time has elapsed, **'HoLd'** appears on the display, in case the cooking temperature is higher than the set holding temperature. Otherwise Proveno holds the food at the set cooking temperature also after cooking.

In case the starting time and operation time were saved in the memory before you managed to set the times desired, first cancel the timer functions by pressing the start or function buttons for about two seconds. The indicator lights of the buttons go off. After that, start activating the time functions from the beginning.

Changing the temperature of timer-set cooking



Press once and select.

Changing the timer-set starting time



Press once and select.

Changing the timer-set cooking time



Press once and select.

Deactivating the activated/programmed timer



Press and keep pressed for about 2 seconds.

Deactivating the activated/programmed operation time



Press and keep pressed for about 2 seconds.

In case the starting time has not yet been reached, the starting time has to be deactivated by pressing the starting time button for about two seconds.

Activating the "egg timer" function and changing the operation time



Press once and select.

- In case none of the Proveno combi-kettle functions is activated, the clock functions as an entirely separate clock, and the buzzer sounds after the set time.
- In case the heating is on, it continues for the set time. After that, the buzzer sounds and the combi-kettle sets to automatic holding (see "Activating the starting and cooking time").
- In case the mixer function is on, the Proveno combi-kettle mixes for the set time, after which the buzzer sounds and the mixer stops.
- In case both heating and mixing functions are on, both functions continue for the set time with the set values, after which the buzzer sounds and the mixer stops. The heating remains at the set value (if lower than the holding temperature) or keeps the automatic holding temperature ('HoLd' on the display).

Stopping the "egg timer" function



Press and keep pressed for about 2 seconds.

4.2.11 Automatic cooling

Cooling is based on cold tap water circulating in the kettle's steam jacket. Mixing and use of scrapers make the cooling more efficient. The cooling time depends, for example, on the product and the amount to be cooled, the product's initial and end temperature, the flow rate and temperature of the cooling water, as well as mixing operations.

Starting the cooling



Press once.



Select the target temperature for the product being cooled.

Wait three seconds until 'no' is displayed. With the central dial, select 'Yes' on the display.



Start the cooling by pressing once.

'Set' is blinking on the display to remind you that mixing makes the cooling much more effective. Choose a mixing operation suitable for the product and the load.

If 'no' remains on the display for 10 seconds, i.e. the 'Yes' selection is not made, the cooling function is cancelled. If you, however, want to start cooling, activate the function by starting from the beginning.

Changing the target temperature during cooling



Press once.



Select a new target temperature (on the display: food temperature).

Cooling continues automatically until the new temperature has been reached.

Continuing the cooling to a lower temperature

When food temperature reaches the temperature set, the flow of cooling water stops, 'rdy' blinks on the display and the buzzer sounds. The mixer continues rotating if this function has been selected.



Press once (buzzer stops sounding).



Select a new target temperature (on the display: food temperature).

The new target temperature is reached, 'rdy' is again blinking on the display and the buzzer sounds.

Maintaining the cooling temperature ('Hold')

The Proveno kettle can maintain the temperature reached.



Press once (buzzer stops sounding).

Food temperature is blinking on the display, but now a new temperature selection is not made.

The 'Hold' function is automatically activated and the kettle starts to maintain the reached temperature, i.e. cooling continues when food temperature rises, but the buzzer does not sound.

Stopping the cooling



Press and keep pressed for about 2 seconds.

When the cooling is stopped, the kettle starts immediately automatic water emptying from the kettle's steam jacket. The display continuously shows the emptying time for the remaining water. During emptying, all the kettle functions, except for tilting, are locked. You cannot cancel the stopping of cooling; the emptying time must be allowed to come to an end.

If the kettle is tilted or the power is cut before the emptying time has expired, emptying will be interrupted and it continues, when the kettle is reverted to an upright position or the power is connected. After the emptying time, the kettle is ready for cooking ('On' is displayed).

4.2.12 Manual cooling (option)

Cooling is based on cold tap water circulating in the kettle's steam jacket. Mixing and use of scrapers make the cooling more efficient. The cooling time depends, for example, on the product and the amount to be cooled, the product's initial and end temperature, the flow rate and temperature of the cooling water, as well as mixing operations.

Starting the cooling

- Set the temperature to 0°C.
- Close the water tap.
- Detach the spray gun from the cleaning hose and connect it to the connector of the emptying valve located under the kettle.
- Open the emptying valve.
- Turn the drain valve to the cooling position.
- Open the cold water tap.

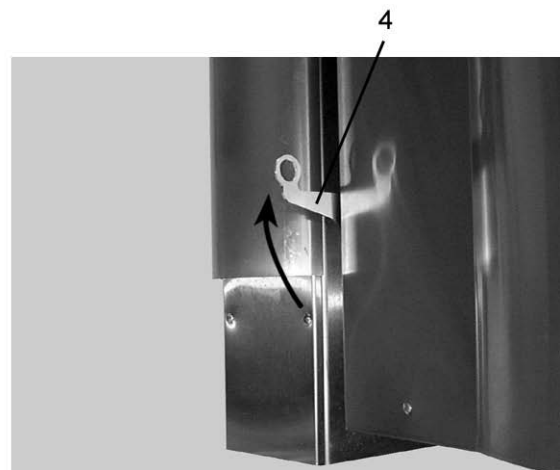
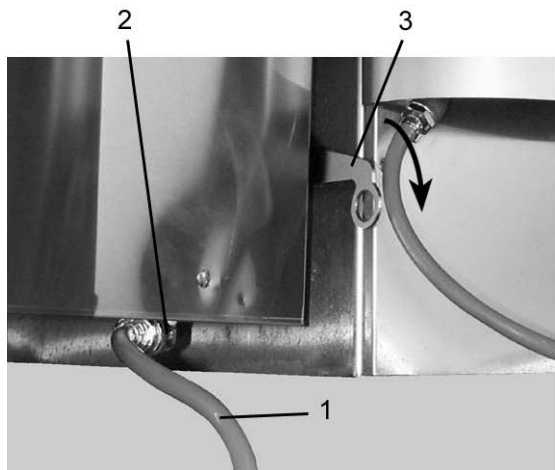



1. Spray gun hose
2. Connector of emptying valve
3. Emptying valve
4. Drain valve

Stopping the cooling

- Close the cold water tap.
- Detach the hand spray hose from the connector of the emptying valve.
- Turn the drain valve to the cooking position.
- Let excess water flow out of the steam jacket into the drain.
- When no more water is flowing from the steam jacket, close the emptying valve.

4.2.13 EasyRun programming

The following functions are possible when a set program is in operation:

-  power mixing
-  interrupting the mixing function
-  stopping the mixing function

stopping with the emergency/stop button.

If you want to collect temperature information (self-control, HACCP), the program in question has to be activated before programming (see "Self-control (HACCP), Activating the collection of self-control data")



The programmed function is performed at the set time during the same day or the following day. This means that you cannot set a program to start, for instance, on the following Monday.

The mixing program of the EasyRun program is a stirring program that cannot be changed.

Activating the program

-  Press once.

Select the values you want by first pressing the button of the appropriate function and by setting the value desired with the central dial:

- 
 - 
 - 
 - 
 - 
 - 
-  Activate the programming by pressing again.

The previously set values are available in the Proveno memory. On the clock display, the starting time and operation time (with letter r in front) alternate. When the program has been activated, all displays show the set values and the indicator light of the PROG button illuminates.

Cancelling the programming

-  Press and keep pressed for about 2 seconds.

The indicator light of the PROG button goes off and 'On' is displayed.

You can cancel the program before it starts in the way described above. If the program has already started, you can cancel/deactivate the program in the same way, whereby the timer is deactivated, but the mixer and heating functions continue. If desired, you can stop the mixer with the STOP button. You can cut the heating by pressing the temperature button for about 2 seconds, until the temperature display shows 'On'.

Changing the program setting values before starting the program (= new programming)

 First cancel the active programming by pressing for about 2 seconds.

Select the desired setting values by first pressing the button of the appropriate program and by setting the desired value with the central dial:



 Activate a new program by pressing once.

When programming has been activated, the set values are shown on all displays and the PROG button indicator light illuminates.

4.2.14 Possible power failure during timing or EasyRun program

A message appears on the timer display indicating power failure during timing or during the starting or operation time of the EasyRun program.

Power failure during the starting time

In case of power failure during the starting time, the kettle's timer display shows, when the power supply is restored, how much the start was delayed:

- during operation time, letter E + delayed time in hours and minutes and the remaining operation time alternate on the display, e.g. E1.10 / r0.58
- after operation time, the display shows letter E + delayed time in hours and minutes, e.g. E1.10

Power failure during the operation time

In case of power failure during the operation time, the kettle's timer display shows, when the power supply is restored, for how long a time the operation was interrupted:

- during operation time, letter E + interrupted time in hours and minutes and the remaining operation time alternate on the display, e.g. E0.12 / r0.46, and the green indicator light on the operation time button is blinking
- after operation time, the display shows letter E + interrupted time in hours and minutes, e.g. E1.12, and the green indicator light on the operation time button is blinking
- in case of several power failures, their durations are summed up

Power failure during both the starting time and operation time

In case of power failure during both the starting time and operation time, the kettle's timer display shows, when the power supply is restored, the total time the timing was delayed:

- during operation time, letter E + total delayed time in hours and minutes and the remaining operation time alternate on the display, e.g. E1.22 / r0.27, and the green indicator light on the operation time button is blinking

Operation instructions

- after operation time, the display shows letter E + total delayed time in hours and minutes, e.g. E1.22, and the green indicator light on the operation time button is blinking
- in case of several power failures, their durations are summed up

4.2.15 Self-control (HACCP) (option)

Instructions on how to use the HACCP program can be found in the Help file of the "SafeTemp self-control" program. The self-control function is an option on models M, C1 and C2. If a message 'InF1' appears on the display, the self-control function cannot be switched on or it has been intentionally switched off by the user. If your Proveno kettle is fitted with the self-control program, which you want to take into use, you have to change parameters according to "Adjustment instructions, Setting customer specific parameters" later in this manual. The parameter for self-control is No. 51.

Activating the collection of self-control data (HACCP)



Press the HACCP button. 'HACC On' blinks on the display and the HACCP button indicator light illuminates.

The text blinks three times, after which a dot at the lower right-hand edge of the temperature display keeps on blinking to indicate data collection.

Stopping the collection of self-control data



Press and keep pressed for about 5 seconds.

'HACC OFF' blinks three times on the display. The collection of temperature data is interrupted and the blinking dot on the temperature display goes off.

4.3 After use

4.3.1 Cleaning



Use of a high-pressure hose is forbidden. High-pressure hoses generate huge amounts of water fog that might contribute to contamination of food and food handling surfaces over large areas in the kitchen.



Switch off the appliance with the ON/OFF switch or the mains switch before starting to wash the kettle.



Tools not allowed for cleaning:

- high-pressure hose
- all metallic tools
- rough rubbing sponges
- steel wool
- abrasive detergents



Tools recommended for cleaning:

- special detergents for stainless steel
- nylon brush
- soft rubbing sponges
- non-abrasive steel wool
- other materials intended for stainless steel that do not scratch the surface



All accessories, such as strainer plates and its parts, mixing tools and scrapers, cooking baskets and parts of the safety lid can be washed in a dishwasher suitable for washing such items.

The less the kettle surface gets scratched, the easier it is to clean. The fastest and easiest method is to clean the kettle every time right after use. Always use a top tray on the control pillar. This will keep the pillar clean. Do not spray water on the control panel. Clean the pillars of the appliance by wiping.



Wash the exterior of the appliance with running water only if necessary. Wiping with a damp cloth will often suffice. Consider the requirements of food hygiene when cleaning the kettle. Abundant use of water for soaking increases water consumption. However, if you want to clean the kettle by soaking, make use of the mixer to make soaking more efficient, mixing slowly during soaking.

Cleaning procedures:

- Switch the appliance off.
- Cool down the kettle with cold water.
- Scrape loose dirt with a plastic scraper (accessory)
- Spray detergent into the kettle, then brush and spray the kettle with water until clean.
- Dry the kettle.

The dosing and impact time instructions for cleaning detergents must be followed - e.g. exceeding the impact time for foam cleaning detergents in combination with salt residues has been observed to cause severe spot corrosion even on stainless steel.

The manufacturer does not take any responsibility for possible damage caused by not following the instructions above.

Detaching the lid parts

- Make sure the kettle is in an upright position.
- Place the lid on the kettle.
- Remove the cover of the safety grid and detach the safety grid.
- Detach the solid lid from the lifting arm by pulling at the locking lever of the lid.



Refitting the lid parts

Place the solid lid on the kettle approximately in the correct position.

Pull the lifting arm down over the lid. Turn the solid lid so that the guiding pin lines up with the groove of the lifting arm.

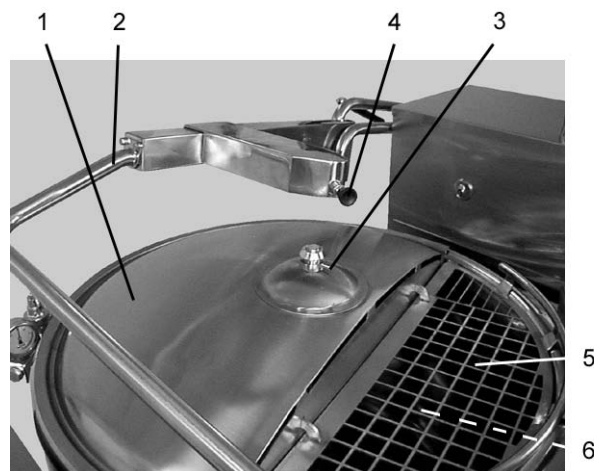

1. Solid lid
2. Lifting arm
3. Guiding pin
4. Locking lever of the lid
5. Safety grid for lid opening
6. Cover for fill opening

Press the lid arm against the lid so that the fixing cone is guided into the fixing part and the locking lever snaps in the locked position. Make sure that the lid is locked on the arm.



Put the safety grid and its cover in place.

4.3.2 Periodic service

Like a car, a food preparation appliance should be kept in good working order with the help of preventive maintenance. This guarantees trouble-free and safe operation of the appliance. Depending on how much the kettle is used and in what kind of conditions it is operated, the technical condition of the Proveno combi-kettle should be checked according to plan from time to time. For example, the amount of scale built up on the steam system depends on the use of the kettle and the hardness of local water. Contact your authorized service provider for recommendations on preventative maintenance to be performed.

4.3.3 Service recording

Keep a record of all service and repair measures carried out for the Proveno combi-kettle during its life cycle. Service history may speed up future service measures, help in controlling the costs and in planning new investments. The safety valve must be periodically checked as instructed in this manual. Enter the check data in the "Maintenance information" table contained in this manual.

5. Installation

5.1 General

Please observe the instructions given in this chapter concerning the installation and adjustments that must be done before taking the Proveno combi-kettle into use. Strict observance of the instructions prevents malfunctions and damages potentially caused by defective installation.

Do not switch the power on if the installation place is damp or wet (building site conditions).

5.1.1 Operating conditions

The Proveno combi-kettle can be used in a normal, air-conditioned professional kitchen. The room temperature of the installation place must not exceed +40°C and the relative humidity must be less than 80% (condensation on surfaces not allowed to occur). If the temperature of the facility in winter conditions is below 0°C, the steam generator of the combi-kettle must be drained and the kettle must be emptied to avoid damage caused by freezing. The kettle's pipes and solenoid valve bodies must be emptied at the same time.

5.1.2 Possible interference from the surroundings (to the surroundings)

The Proveno combi-kettle fulfils the requirements of the EMC directive concerning the emissions and immunity to electromagnetic disturbances. In case there are electronically controlled appliances and, in particular, devices fitted with a frequency converter in the installation place, it is recommended to ensure their conformity with the relevant regulations and that their cabling has been done according to instructions.

5.1.3 Storage

The Proveno combi-kettle must be stored in a dry place, at a temperature between +10 and +40°C. The kettle should be kept in its transport package during storage.



If the appliance is stored in construction site conditions, special care must be taken not to damage it through other operations on the site.

- Protect the exterior of the combi-kettle from scratches and knocks.
- Protect the combi-kettle from construction site dust.

- Protect the combi-kettle from sparks produced by welding, grinding and abrasive cutting wheels. These can later cause rust spots on the stainless steel surface of the appliance.

5.1.4 Unpacking the appliance

The combi-kettle should be transported in its own package as close as possible to the installation place before final unpacking. Do not remove the protective foils until after installation, just before the first use of the kettle.



After removing from the transport pallet, the combi-kettle is not stable until it has been bolted down to the installation frame. It is strictly forbidden to operate or tilt the kettle before it has been fixed to the floor according to the installation instructions. When the combi-kettle is removed from its transport pallet, it must be supported to prevent it from falling before it is fixed to the floor. If the kettle falls down, this may cause injury to people or damage to property.

5.1.5 Disposal of the package

In connection with unpacking, all packing material must be sorted and disposed of in accordance with local recycling regulations.

5.2 Installation

Check before installation from the installation drawing that there is enough space behind the kettle for tilting and servicing. Also check the location of the floor drain.



The Proveno combi-kettle is designed for installation in a place with a floor drain in front of the kettle. The arrangement with a pouring channel and floor drain behind the kettle is not suitable for use with the combi-kettle

The combi-kettle can be installed in two different ways:

- On a subsurface installation frame, the frame cast into the floor
- On a surface installation frame, the frame fixed to the floor surface



Fixing the kettle directly to the floor without frames is forbidden.

Either subsurface frames or surface frames must be in position before the installation of the combi-kettle is started.

Installation

5.2.1 Subsurface frame cast into the floor

Installation frames are mounted according to the installation drawing, with the help of distance guides supplied with the delivery. The frames must be installed in a horizontal position and fixed so that they do not move during casting. The installation frames must be positioned so that their upper surface is 30 mm above the finished floor surface. The junction of the installation frame and floor is filled with flooring material or silicone mastic. To achieve the best result regarding tightness, the installation frame should be filled up to the top level e.g. with acrylic filler **after the installation**. The main points concerning the installation of the subsurface frame are shown in the picture below. For more detailed installation instructions, see the installation drawings.

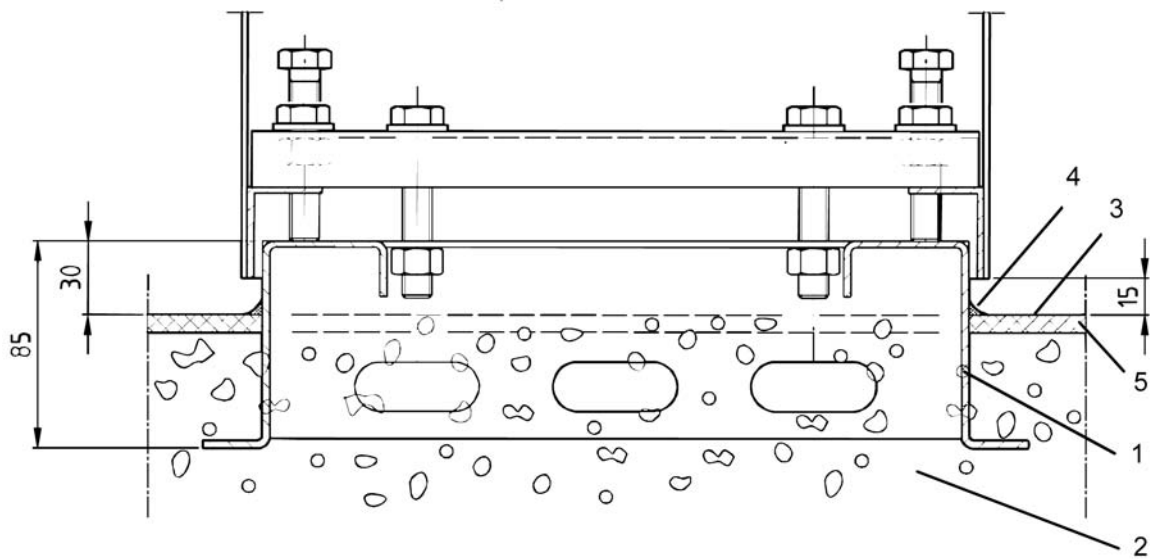

1. Installation frame
2. Concrete casting
3. Finished floor surface
4. Silicone mastic
5. Acrylic filler

Place the kettle on the installation frame and adjust to a horizontal position with the adjusting bolts which are in the corners of the pillars. When the kettle is in a horizontal position, it must be fixed to the installation frames with the help of M12 fixing bolts. The control pillar has 4 bolts and the support pillar has 2 bolts. Tighten the adjusting nuts carefully. Do not seal the space between the kettle pillars and installation frame as there must be enough change of air.

5.2.2 Surface installation frame fixed to the floor

Surface frames are mounted according to the installation drawing, with the help of distance guides supplied with the delivery. If the inclination of the floor is very steep, it may be necessary to level the surface frame closer to the horizontal by placing stainless steel spacers between the frame and the floor. This will ensure that the adjustment range of the pillars is adequate.



Pieces of stainless steel plate should be used as spacers that are large enough and have a suitable hole for the fixing bolt. Washers or other small spacers are not allowed.

The fixing bolts for the surface installation must be chosen according to the floor construction. A type recommended is a UKA M10x150 chemical bolt, which suits various floor materials. The junction of the surface frame and the floor is filled with flooring material or silicone mastic. To achieve the best result regarding tightness, the installation frame should be filled up to the top level e.g. with acrylic filler **after the installation**. The main points concerning the installation of the surface frame are shown in the picture below. For more detailed installation instructions, see the installation drawings.

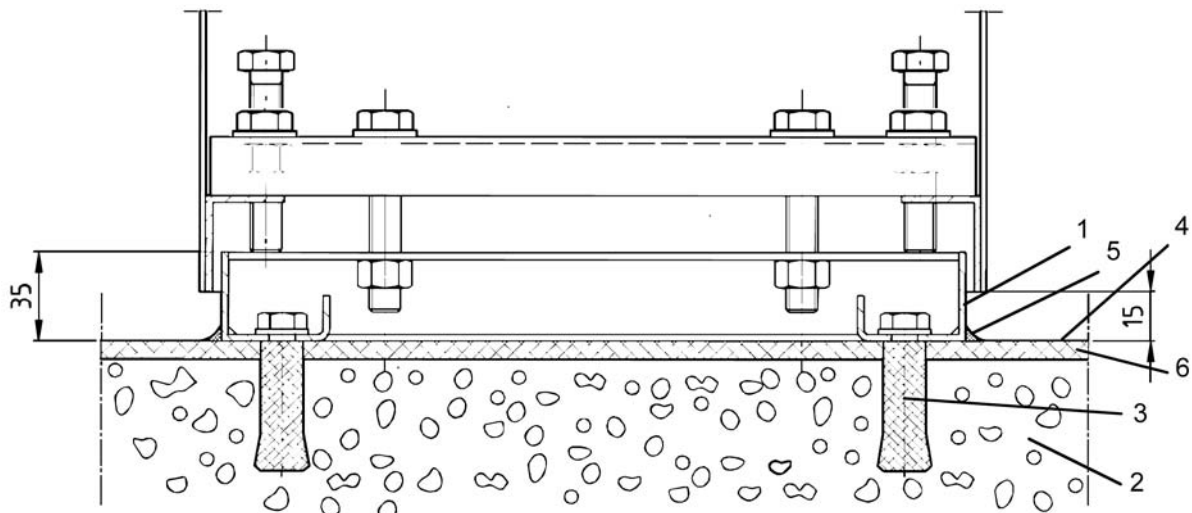

1. Surface frame
2. Concrete casting
3. Fixing bolt for surface frame
4. Finished floor surface
5. Silicone mastic
6. Acrylic filler

Fixing bolts of the surface installation must be chosen according to the floor material. Recommended type is a UKA 12x200 chemical bolt, which is suitable for different floor materials. Alternatively expansion-shell bolts or equivalent can be used.

Place the kettle on the surface installation frame and adjust to a horizontal position with 4 adjusting bolts which are in the corners of the pillars. When the kettle is in a horizontal position it must be fixed to the surface frame with the help of M12 fixing bolts. The control pillar has 4 bolts and the support pillar has 2 bolts. Tighten the fixing nuts carefully. Do not seal the space between the kettle pillars and surface installation frames, as there must be enough change of air.

5.2.3 Installing the combi-kettle on the frame

The front and rear cover plates of the kettle's support and control pillar must be detached before installation. Each plate has been fixed at its lower edge with two screws. The rear plate of the control pillar has, in addition, two screws at the upper edge. After detaching, the support chain holds the front cover so that the ribbon cable would not accidentally be damaged. After that, it is also possible to detach the lead-through plate of supply cables and water pipes located at the lower rear edge of the control panel by loosening four screws.

Installing the support pillar

Start installing the combi-kettle or kettle group by first positioning the left-hand support pillar in place. Lift the support pillar (1) on the installation frame (2) and adjust it by means of the adjusting bolts (3) located on the corners to a horizontal position and to a height of 900 mm measured from the top of the support pillar front edge to the floor. When the support pillar (1) is in place, fix it with two fixing bolts (4) to the installation frame (2).

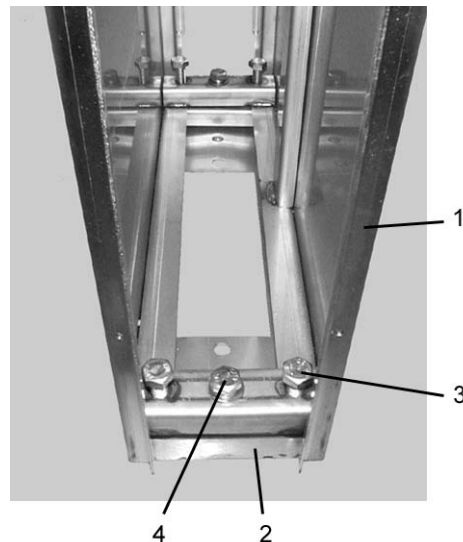

1. Support pillar
2. Installation frame
3. Adjusting bolt
4. Fixing bolt

Next, the bearing unit (2) and the cover plate for axle lead-through (3), both supplied with delivery, are installed on the support frame (1). First position the assembled bearing unit (2) on three upper bolts. Fix the washer and nut (5) to the uppermost bolt to hand tightness. Then install the mounting bracket (4) of the cover plate on two lower bolts and fasten the washers and nuts (5) to hand tightness. After that fix the cover plate (3) with the washer and nut. Check that the bearing unit (2) and the cover plate (3) hole are concentric before you tighten all the fixing bolts (5) (6).

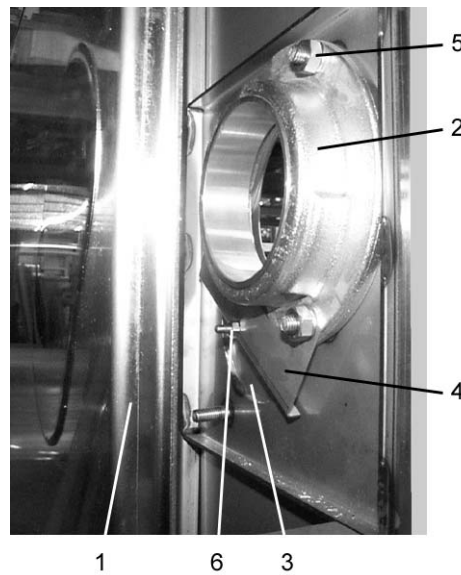

1. Support pillar
2. Bearing unit
3. Cover plate
4. Mounting bracket for cover plate
5. Washer + nut
6. Washer + nut

Installing the kettle section

The kettle can be transferred from its transport pallet onto the installation frame in two different ways.

The first alternative is to cut the longitudinal boards of the pallet and push the fork-lift trolley below the kettle.



Care must be taken that the lifting arms of the fork-lift trolley do not hit the parts protruding from the kettle bottom, i.e. the mixing motor cover box (Proveno 40, 60, 80, 100) as well as the drain and discharge pipes.

Furthermore, it is recommended to place e.g. plywood strips between the fork-lift trolley and the kettle bottom. Before lifting, the transport support of the kettle's left-hand axle and the support pillar are detached from the transport pallet. It should be observed that, owing to the ball-shaped bearing, the kettle control pillar also moves sideways. It is advisable to put a piece of foamed plastic or a rolled cellular board between the kettle and control pillar so that they do not hit each other.

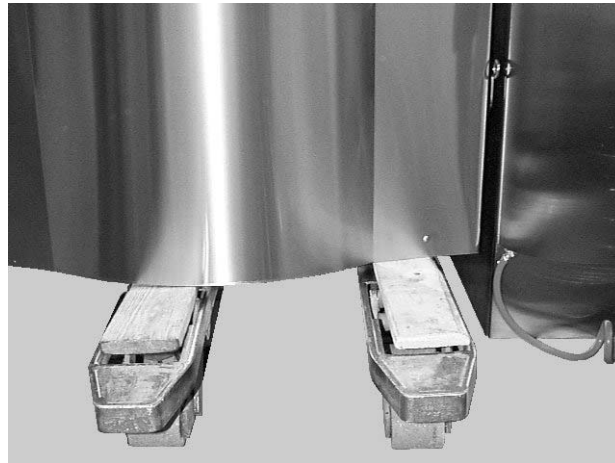

The second alternative is to transfer the kettle by lifting the kettle section by its left-hand axle and by a lifting bar pushed through the control pillar. The lifting bar is positioned below the cross supports, located at the front and rear edge of the control pillar, slightly above the bearings.



When pushing the support through the control pillar, be careful not to damage the cables and water pipes.

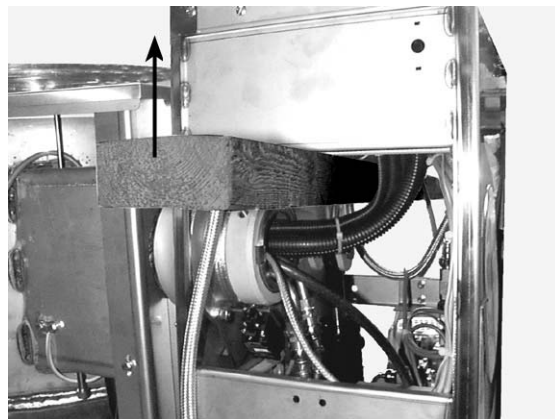

Before the left-hand axle of the kettle is pushed into the support pillar bearing, remember to put a gasket (1) on the axle. Make sure that the shoulder of the axle lines up with the bearing and lock the axle with a lock ring (2) and fixing bolts (3).

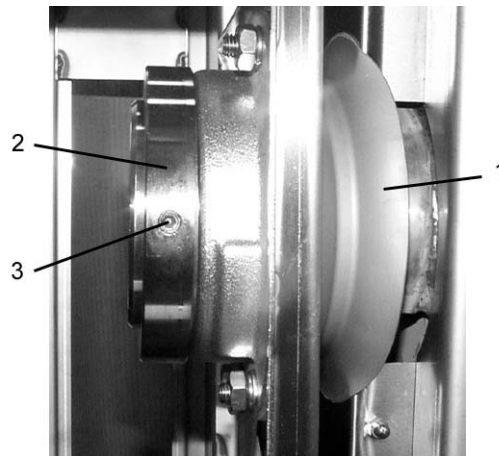

1. Gasket
2. Lock ring
3. Locking screw

Next, the control pillar (1) is adjusted by means of the adjusting bolts (3), located on the corners, to a horizontal position and on the same level with the support pillar. When the control pillar (1) is in position, it is fixed to the installation frame (2) with four fixing bolts (4). Check that the space between the kettle section and the support and control pillars is the same, both at the top and at the bottom.

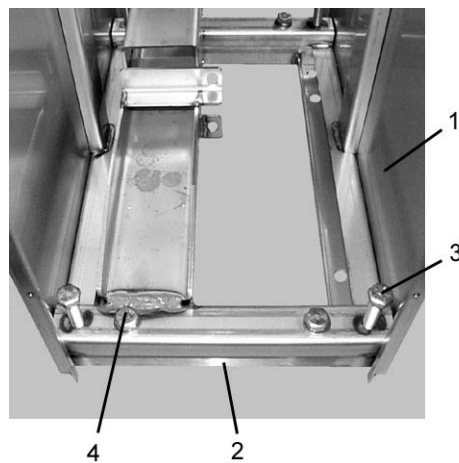

1. Control pillar
2. Installation frame
3. Adjusting bolt
4. Fixing bolt

In this phase the front and rear cover plates of the support pillar can be refitted.

Installing the following kettle section

If a kettle group is being installed, proceed as follows:

Before installing the next kettle section, remove the bearing cover plate of the kettle already installed. After this, install the bearing unit and the axle lead-through cover plate, supplied with the kettle delivery, exactly in the same way as it was installed on the support pillar.

The installation of the next kettle section on the control pillar of the previous kettle takes place in the same way as the installation of the first kettle on the support pillar.

5.3 Electrical connections



The electrical connections of the Proveno combi-kettle can only be carried out by a qualified electrician having the necessary competence for the installation and service of electrical appliances.



The support pillar cover plate, including the water tap, is a fixed component, not intended for detaching. Do not force it upwards when removing the upper side plate.

To make the electrical connections, the upper left-hand side plate, where the mains switch is located, must be removed and the cover of the electrical box underneath must be opened.

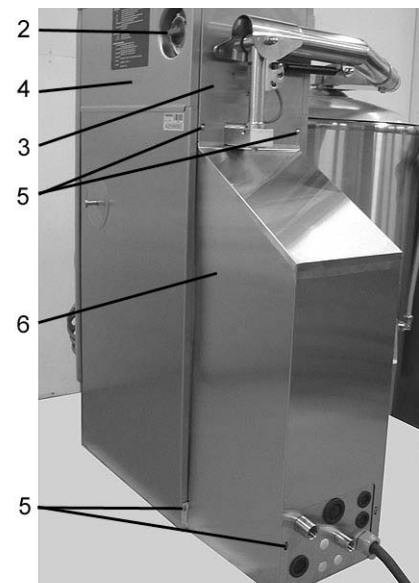
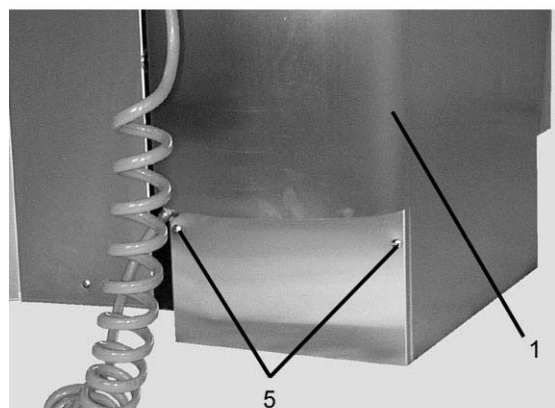

1. Front plate
2. Mains switch
3. Upper rear plate
4. Upper side plate
5. Screw
6. Rear box

Turn the mains switch (2) to the OFF position.

If the control pillar front plate (1) is in place, it must be first detached by opening two screws (5) at the lower section of the plate.

Detach the rear box (6) and the upper rear plate (3) by opening the screws (5). The cable of the lid switch hinders the upper rear plate being detached entirely, but you can move the plate a little aside.

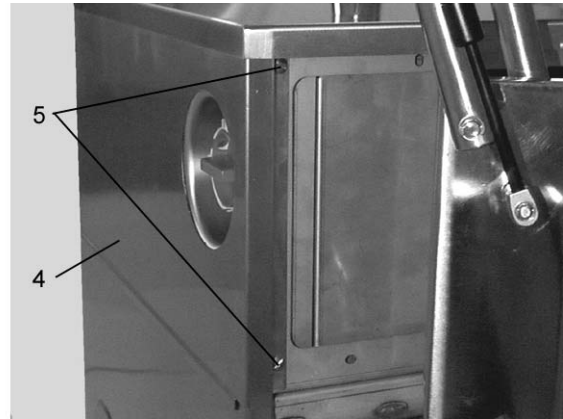
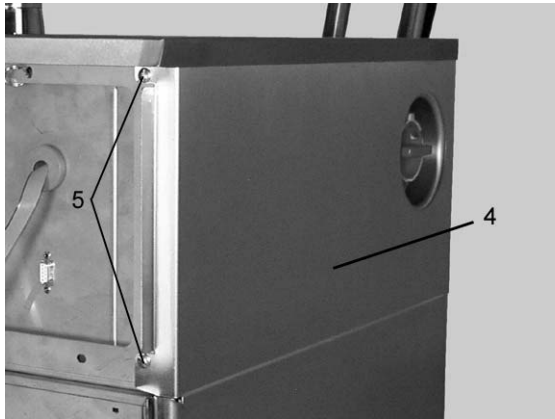

- 4. Upper side plate
- 5. Screw

Loosen the four screws (5) located on the upper and lower corners of the upper side plates (4).

Turn the lower part of the upper side plate (4) cautiously outwards and after that straight downwards.

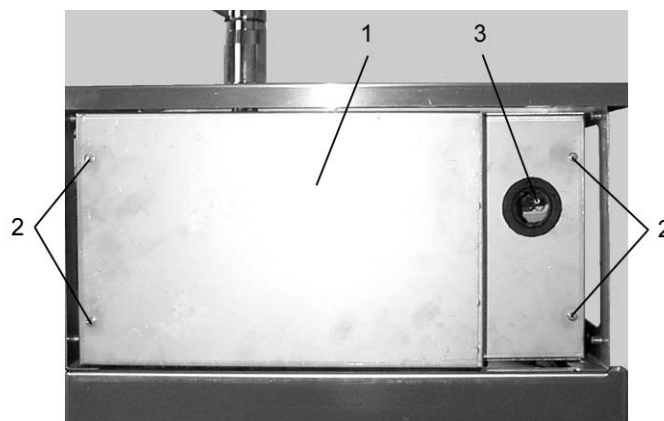

- 1. Cover
- 2. Screw
- 3. Shaft

Open the screws (2) on the electrical box cover (1) and remove the cover. Be careful that the mains switch shaft (3) does not get loose from the switch.

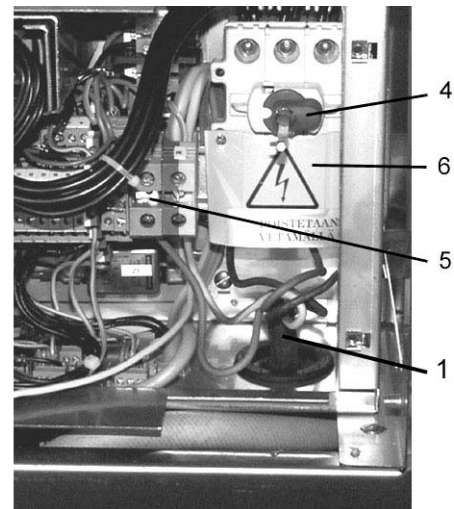
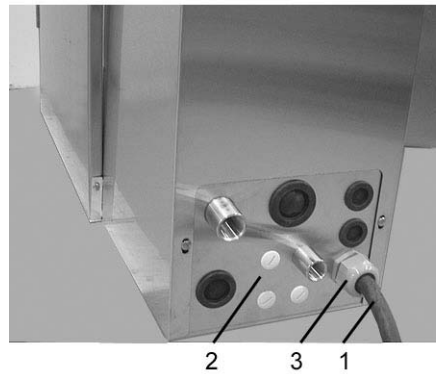

1. Supply cable
2. Lead-through plate
3. Cable bushing
4. Mains switch
5. N and PE cables
6. Cover plate

Detach the cover plate (6) of the mains switch by pulling. Detach the lead-through plate (2) from the rear box. Slip the supply cable (1) through the cable bushing (3) of the lead-through plate and upwards via the lead-through of the electrical box further to the mains switch (4). Connect the phase wires of the cable to the mains switch and N and PE cables (5) to the terminal blocks.

After that, check phase order to make sure that the mixer and tilting motors rotate in the correct direction.

Close the lid and safety grid of the combi-kettle, but do not put the cover of the safety grid on.



Turn the mains switch to position I and switch the combi-kettle on with the ON/OFF switch.



Start the mixer by first pressing the mixing function button and after that the mixer start button.

The mixer should rotate clockwise.



Stop the mixer by pressing the red STOP button.

On hydraulically tilted Proveno 200 and 300 combi-kettles, you still have to check the rotation direction of the hydraulic pump motor.



Open the kettle lid and tilt the kettle by pressing the tilting button.

The correct rotation direction is anticlockwise viewed from the motor's cooling fan end. An arrow indicating the rotation direction is fixed to the motor on the same side where the connection box is located.

If the rotation direction in two foregoing points is wrong, two phases of the supply cable coming to the mains switch have to be exchanged.

Tighten the screws of the cable connections and the cable bushing properly, press the cover plate of the mains switch in place, refit the electrical box cover, the upper rear plate and the upper side plate.

5.4 Water connections



Water connections of the Proveno combi-kettle can only be carried out by a person with professional competence in the installation and service of heating, plumbing and air conditioning equipment.

The location of the water connection points appears from the installation drawing. Both cold and hot water connections must be fitted with a closing valve and a non-return valve (not included in delivery). The sizes of water connection points are as follows:

Cold water: connection with R1/2" inner thread, supply with min. 15 mm inlet pipe

Hot water: Cu pipe, outer dimension 10 mm, supply with 10 mm inlet pipe (max. +60°C)



If the cold water inlet pipe is smaller than 15 mm, water flow will decrease and the filling times will be longer than indicated.

5.4.1 Icebank connections (C3 option)

The location of the connection points of an external icebank appears from the installation drawing.

Icebank in: R1/2" inner thread. The icebank must be fitted with a solenoid valve to stop the flow of cooling water after cooling has ended.

Icebank out: R3/4" inner thread.

5.4.2 Water connection and quality requirements

- The unit must be connected to the cold and warm water supply.
- All water supply lines must be fitted with a one-way valve and a shut-off valve (not included in delivery).
- Before connection to the unit all water lines must be thoroughly rinsed from all loose particles.
- The water pressure range for optimum performance is 250 - 600 kPa.
- The minimum water pressure allowed for proper function of the unit is 250 kPa. If the pressure is lower, a pressure rise pump must be fitted by the customer.
- The minimum water flow rate is 5 l/min, however, if optimum cooling capacity is required, the cold or soft water flow rate must be at least 20 l/min.

- All water connections are of size Ø15mm (R 1/2").
- Water conductivity should be below 1000µS/cm. Already when the conductivity is over 500µS/cm, a water analysis is recommended.
- Maximum chloride concentration allowed is less than 60 mg/l.
- Maximum chlorine concentration allowed is less than 0,2 mg/l.
- The pH value of the water should be between 6,5 and 9,5.
- Unit damages caused by chloride, chlorine or pH values exceeding the stated limits are not covered by manufacturer warranty.

5.4.3 Extreme water conditions

When extreme water conditions not fulfilling the requirements above exist, filters and water treatment devices should be installed in order to ensure proper function of the unit and avoid corrosion. When extreme water conditions are at hand, a water quality analysis must be carried out. Depending on the results of the analysis, needed filters and water treatment devices are installed by the customer. The most common filters and treatment equipment are:

1. Particle filter

A 5-15µm particle filter is recommended when water contains sand, iron particles or other suspended matters.

2. Active carbon filter

An active carbon filter must be used if the chlorine level exceeds 0,2 mg/l.

3. Reverse osmosis system

A reverse osmosis system must be used if the chloride concentration exceeds 60 mg/l. This is very crucial in order to avoid corrosion.

5.5 Steam and condensate connections



The steam and condensate connections of the Proveno combi-kettle must be carried out by a person with professional competence in the field. Improper connections and pipings may severely impact the correct function of the kettle.

The location of the steam and condensate connection points appears from the installation drawing.

The maximum steam pressure in the kettle is 1 bar. The steam supply line must be fitted with a one-way valve, a shut-off valve, a filter, a pressure reduction valve and a safety valve set at 1,5 bar.

The condensate pipe must be on the same floor as the kettle or go to the floor below. Leading the condensate pipe to the floor above the kettle is not allowed, as it creates a water trap that prevents normal function of the kettle.

The condensate pipe must be free from pressure created by other appliances.

5.6 Ventilation

The heat and steam load of the kettle must be taken into account in the kitchen's ventilation plan. A ventilation hood must be installed above the kettle, because plenty of steam is released when the kettle lid is opened. When dimensioning the ventilation hood, the space requirement for opening the lid must be taken into account (see installation drawing).

5.7 Other installations

In case the combi-kettle being installed is provided with a self-control option, and it is taken into use, the data cabling and the installation of the program must be carried out according to the instructions in the Help file of the "SafeTemp self-control" program.

5.8 Procedures after installation

5.8.1 Adjusting the tilting

Before refitting the cover plates on the combi-kettle control panel, you have to check and, when needed, adjust the operation of tilting.

On hydraulically tilted Proveno 200 and 300 combi-kettles, first check the rotation direction of the hydraulic pump. The correct rotation direction is anticlockwise viewed from the motor's cooling fan end. If the rotation direction is wrong, two phases of the supply cable coming to the mains switch have to be exchanged.

Next you have to ensure that the kettle is horizontal when it is in the cooking position. Before that make sure that the combi-kettle's control pillar has been installed horizontally. Checking is done as follows:

- First tilt the kettle at least half-way and after that press the tilting reverse button as long as the kettle stops in the cooking position.
- Check the kettle's horizontal by the upper rim of the kettle.

If the kettle is not horizontal, the position of the mounting plate of the tilting limit switches must be adjusted as follows:

- Tilt the kettle at least half-way.
- Loosen the locking nut for adjustment (5) and the fixing nut for the limit switch plate (6) so that the limit switch plate (1) can be moved, but after moving stays in the new point.
- If the combi-kettle in its cooking position is tilted too much towards the spout, turn the limit switch plate (1) slightly downwards. In case the kettle in its cooking position is tilted too much backwards, turn the limit switch plate (1) slightly upwards.
- Tighten the locking nut (5) slightly after adjustment, press the tilting reverse button until the kettle tilting stops and check the kettle's horizontal again by the upper rim of the kettle.
- Tighten both the fixing nut (6) and the locking nut (5), if the combi-kettle is horizontal in its cooking position. Otherwise, repeat the adjustment measures.

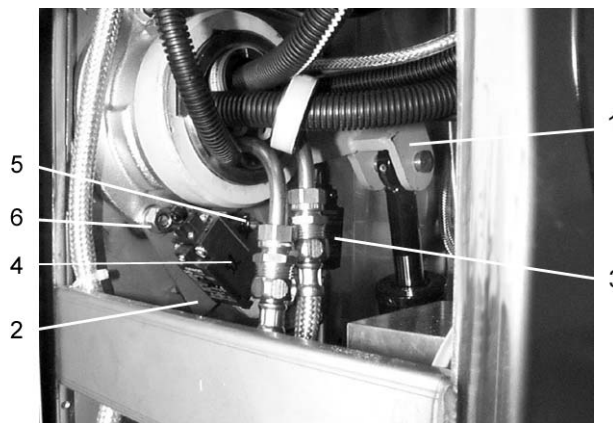

1. Tilting lever
2. Mounting plate of limit switches
3. Limit switch for cooking position
4. Limit switch of tilting end position
5. Locking nut for adjustment
6. Fixing nut for bearing unit and limit switch plate

5.8.2 Fastening the mixer motor cover box

On the large kettle models (Proveno 150, 200, 300, 400), the cover box of the mixing motor comes unattached inside the kettle. The cover box is fastened after installation by using the screws supplied while the kettle is in a tilted position.

5.9 First run and testing

The following checks must be performed after the installation before taking the Proveno combi-kettle into regular use.

5.9.1 Switching the kettle on

- First check that the closing valves coming to the kettle are in the ON position and the kettle's mains switch is in position ON.
- Switch the kettle on with the ON/OFF button.
- Check that the kettle section is in the cooking position by pressing the tilting reverse button.

5.9.2 Checking the safety block

It is the responsibility of the user to check the safety block of the combi-kettle **four** times a year. Ask a qualified person to carry out the check as follows:

- Open the safety valve while the kettle is pressurized by lifting the safety valve lever.
- When the steam is discharging (sound, pressure gauge reading reduces) allow the lever to return to the lower position.



Beware of hot steam discharging from the safety valve!

5.10 Adjustments, programming

The Proveno combi-kettle has been programmed in the factory with values suitable for the needs of professional kitchens. The combi-kettle is, however, provided with a "CSFP" technology (Customer Specific Function Parameters), which makes it possible to alter certain functions to better suit the specific needs of an individual customer or kitchen.

Should adjustments be needed, see "Adjustment instructions" for customer specific setting values.

Parameter values for adjustment by authorized service personnel are given in a separate service manual.

5.11 Staff training

Before taking the Proveno combi-kettle into use, make sure that the operators have sufficient information about the correct and safe use of the kettle.

5.12 Combination of machines

When the kettle is connected to a closed loop cooling system, a combination of machines as specified in the machinery directive is created for which, at commissioning, a signed declaration of conformity must be provided covering the combination of machines.

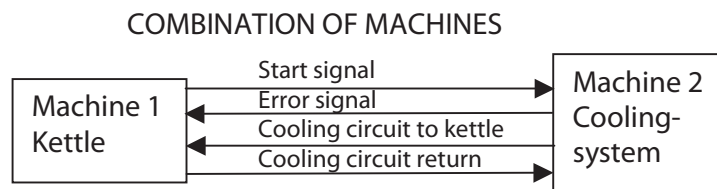

6. Adjustment instructions

6.1 Setting customer specific parameters

By setting the customer specific parameter it is possible to modify certain functions of the Proveno combi-kettle to better suit a kitchen's or customer's individual needs. In general, the preset factory settings are well suited to most users, so the settings need only be modified to meet the special conditions or modes of operation in a kitchen. The customer specific parameters are normally set by the person in charge of the kitchen activities.



The combi-kettle has to be in the stand-by mode when starting to alter customer specific parameters. This means that 'On' is shown on the temperature display and the time on the timer display (in case the kettle is fitted with a timer option). No functions are allowed to be in operation.

The customer parameter setting mode can be accessed as follows:

Simultaneously press the temperature and the tilting reverse buttons for 3 seconds:



'CodU' appears on the temperature display.



After this press the temperature button for 3 seconds.

The first parameter 'Pr00' appears on the temperature display.



By using the central dial, search within 3 seconds the desired parameter between Pr00 - Pr52.



When the desired parameter appears on the display, press briefly the temperature button.

In case the parameter is in use, its setting value is shown on the display of the function it relates to.



Functions have not been defined for all parameters. The table at the end of this chapter specifies the parameters in use.



Change the parameter using the central dial.



Confirm the new setting by pressing the temperature button for 3 seconds.

When the displayed value goes out, this indicates that the new setting has been saved in the memory.

Adjustment instructions



Select a new parameter using the central dial and wait for 10 seconds, so the combi-kettle will revert to the stand-by mode.

6.2 Customer specific parameters, settings and factory presets

The following table contains the parameter values starting from program revision Or54. The program revision is visible on the temperature display a short moment after switching the kettle on.

Pr code	Function	Display	Value		Factory preset
Pr10	Default cooking temperature	Temperature Timing	hPt 0 - 120		80
Pr11	Used temperature unit	Temperature	hEC hEF	Celsius Fahrenheit	hEC
Pr12	Default Hold temperature automatically set after the cooking process	Temperature Timing	hold 51 - 100		70
Pr13	Central dial selection delay (sec.) after which the selected value is locked	Temperature	td_2 - td_7		td_5
Pr14	Low-temperature area (51-69°C heating temperature difference)	Temperature	hd 0 - hd30		Hd10
Pr15	Mid-temperature area (70-87°C) heating temperature difference	Temperature	nd 0 - nd30	87°C temperature fixed 100°C	nd30
Pr16	Cooking temperature area (88-100°C) heating temperature difference	Temperature	Hd 0 - Hd13		Hd13
Pr20	Selection and deselection of the short pull back of the tilting done after releasing the tilting	Temperature	Fbon FboF	Pull back ON Pull back OFF	Fbon
Pr21	Selection and deselection of the buzzer signal used when pausing and ending the mixer	Temperature Mixer	AL on oFF	Buzzer ON Buzzer OFF	on
Pr30	Water bypass time (min.) of the automatic water filling system. Used to empty long water supply lines of possibly musty water.	Temperature Water fill	Fti 0 - 10	0 = no bypass flow done	1
Pr31	Water bypass interval (hours) of the automatic water filling system. When the interval has elapsed a new bypass flow is done.	Temperature Water fill	Fdi 0 - 24	0 = bypass flow always done	12
Pr32	Automatic water filling unit selection	Water fill	Lit/GAL		Att! Pr01 Lit
Pr40	Default cooling final	Temperature Info	CFt 0 - 100		30
Pr41	C5 cooling temperature setpoint when tap water cooling is changed to Ice Bank	Temperature Info	C2C3 0-100	0=C2 100=C3	75
Pr42	C5 cooling tap water emptying delay before Ice Bank emptying delay	Temperature Info	C5td 0-15	0 = not in use	0
Pr43	Preset time (min.), after which the cooling is aborted if the temperature doesn't decrease any more	Temperature Info	Cdt2 0 - 4.00	0 = cooling abortion switched off	0.15
Pr44	Mixer program 1 - soft mixing Activated when set cooling temperature reached	Temperature Mixer	Soft on/off	off = pause 2 min on = pause 10 min	Att! Pr01 OFF
Pr50	No longer used				

Adjustment instructions

Pr code	Function	Display	Value		Factory preset
Pr51	Appliance identification code for the HACCP data collection	Temperature Mixer	HAC2 0 - 99	0 = HACCP switched off	0
Pr52	Setting of HACCP data collection interval (min.)	Temperature Mixer	HAC3 1, 5 or 10		1

Pr14 added 27.5.2002 (Or65)

Pr15 added 27.5.2003 (Or71)

Pr16 added 3.6.2003 (Or71)

Pr41 added 15.9.2003 (Or73)

Pr42 added 15.9.2003 (Or73)

Pr32 added 3.3.2008 Pr01 (new panel)

Pr44 added 3.3.2008 Pr01 (new panel)

7. Troubleshooting

MALFUNCTION	POSSIBLE CAUSE	WHAT TO DO
The kettle cannot be switched on	The mains switch is in the OFF position	Turn the mains switch fitted on the rear part of the control pillar right side to the ON position
	The emergency/stop button is pushed	Release the emergency-stop switch by turning it clockwise
	The fuses in the main fuse box are blown/triggered	Change/replace the fuses
	The delivery of electric energy is interrupted	Check if the delivery of electric energy is interrupted elsewhere and wait for it to return
The kettle does not heat	The timer function is activated if the kettle is equipped with a timer	Switch off the timer function according to instructions
	The EasyRun function is activated if the kettle is equipped with the option	Switch off the EasyRun function according to instructions
	The emergency/stop button is pushed	Release the emergency-stop switch by turning it clockwise
	The ON/OFF switch is not in the ON position	Push the switch to the ON position
	On a kettle fitted with automatic cooling: The draining of the cooling water is still unfinished	Wait until time on the display next to the cooling button runs out
	The fuses in the main fuse box are blown/triggered	Change/replace the fuses
	The kettle is not returned to an upright position after tilting, the temperature display shows a 'PoS' signal	Press the tilting reverse button until the kettle is totally horizontal and the temperature display shows an 'On' signal
	Electric kettle: Not enough water in the steam-generator, the two red error lights on the control panel are illuminated	Check that the shut-off valve of the water supply line is in the OPEN position
	Steam kettle: The shut-off valve of the steam input is closed	Open the valve
Other technical fault	Contact qualified technical personnel	
Heating of the kettle is slow	Electric kettle: Too much water in the steam-generator	Check the water level of the steam generator according to the instructions by opening the emptying valve.
	Steam kettle: Condensate water gathered in the steam jacket has not been emptied	Remove the condensate by opening the emptying valve which is in the steam jacket
	The steam jacket of a kettle equipped with a manual cooling system (C1) is full of cooling water which has not been emptied	Remove the chilling water by opening the emptying valve (electric) or the emptying valve for condensate (steam)
	There is air in the steam jacket which does not flow out because the automatic vacuum valve does not function	If the air does not exit through the automatic vacuum valve, contact qualified technical personnel
	One of the fuses in the main fuse box is blown/triggered	Change/replace the fuse
	The forced 1/2-power control of the building is on	Normal operation
	Other technical fault	Contact qualified technical personnel

Troubleshooting

The kettle does not tilt	The lid of the kettle is on and the mixer display shows a 'Lid' signal	Open the lid
	The emergency/stop button is pushed	Release the emergency-stop switch by turning it clockwise
	The ON/OFF switch is not in the ON position	Push the switch to the ON position
	Other technical fault	Contact qualified technical personnel
The mixer does not start	The emergency/stop button is pushed	Release the emergency-stop switch by turning it clockwise
	The lid and the safety grid are not in their correct positions on the kettle, the mixer display shows a 'Lid' signal	Place the lid and safety grid in their correct positions on the kettle and restart
	No mixer mode has been selected after selecting the mixer	First select the mixer function and then select the mixing (see the user manual "Mixing functions")
	The fuses in the main fuse box are blown/triggered	Change/excite the fuses
	All above mentioned sections have been checked, both red error lights on the control panel are flashing	The safety switch of the safety grid is damaged and for safety reasons the operation of the mixer is inhibited. Contact qualified technical personnel.
	Other technical fault	Contact qualified technical personnel
The mixer stops during mixing	The lid and the safety grid are not in their correct positions on the kettle, the mixer display shows a 'Lid' signal	Place the lid and safety grid in their correct positions on the kettle and restart
	The emergency/stop button has accidentally been pushed	Release the emergency-stop switch by turning it clockwise
	A pre-set program including stopping of the mixer is in use	Check if a pre-set program is in use
	The stuff to be mixed is too thick or there is too much contents in the kettle	Make the contents of the kettle thinner or reduce the amount and restart
	Other technical fault	Contact qualified technical personnel
Timing of the kettle not possible	The kettle is not returned to an upright position after tilting, the temperature display shows a 'PoS' signal	Press the tilting reverse button until the kettle is totally horizontal and the temperature display shows an 'On' signal
	The lid and the safety grid are not in their correct positions on the kettle, the mixer display shows a 'Lid' signal	Place the lid and safety grid in their correct positions on the kettle
	Other technical fault	Contact qualified technical personnel
The automatic water filling does not fill any water into the kettle	The shut-off valve of the water supply line is in the closed position or the whole water supply network is closed, an 'Err' message is blinking on the water fill display.	Open the shut-off valve or wait until the water supply is restored, and start the automatic water fill again.
	Other technical fault	Contact qualified technical personnel
It is not possible to activate the EasyRun program	The kettle is not returned to an upright position after tilting, the temperature display shows a 'PoS' signal	Press the tilting reverse button until the kettle is totally horizontal and the temperature display shows a 'On' signal
	The lid and the safety grid are not in their correct positions on the kettle, the mixer display shows a 'Lid' signal	Place the lid and safety grid in their correct positions on the kettle
	Other technical fault	Contact qualified technical personnel
The automatic cooling program is interrupted although the set temperature is not reached	The temperature of the cooling water is so high that it is not possible to reach the set temperature, the reached temperature is flashing on the temperature display	Select a final temperature that is possible to reach with the temperature of the cooling water at hand. If there is a need for lower temperatures, please contact your dealer for information on ice bank cooling systems.

Troubleshooting

When you contact service personnel, give the following information for the unit in question:

- what is the type and model of the unit
- what is the serial number of the unit and the date the unit has been installed
- a short description of the fault, what function is not working, what signals are the displays showing
- what happened/was done immediately before the fault occurred

8. Technical specifications

Connection diagram S00123 B3

Installation drawing L00094 G3

Text part L00122 C3

Steam supply recommendations 000030 A4

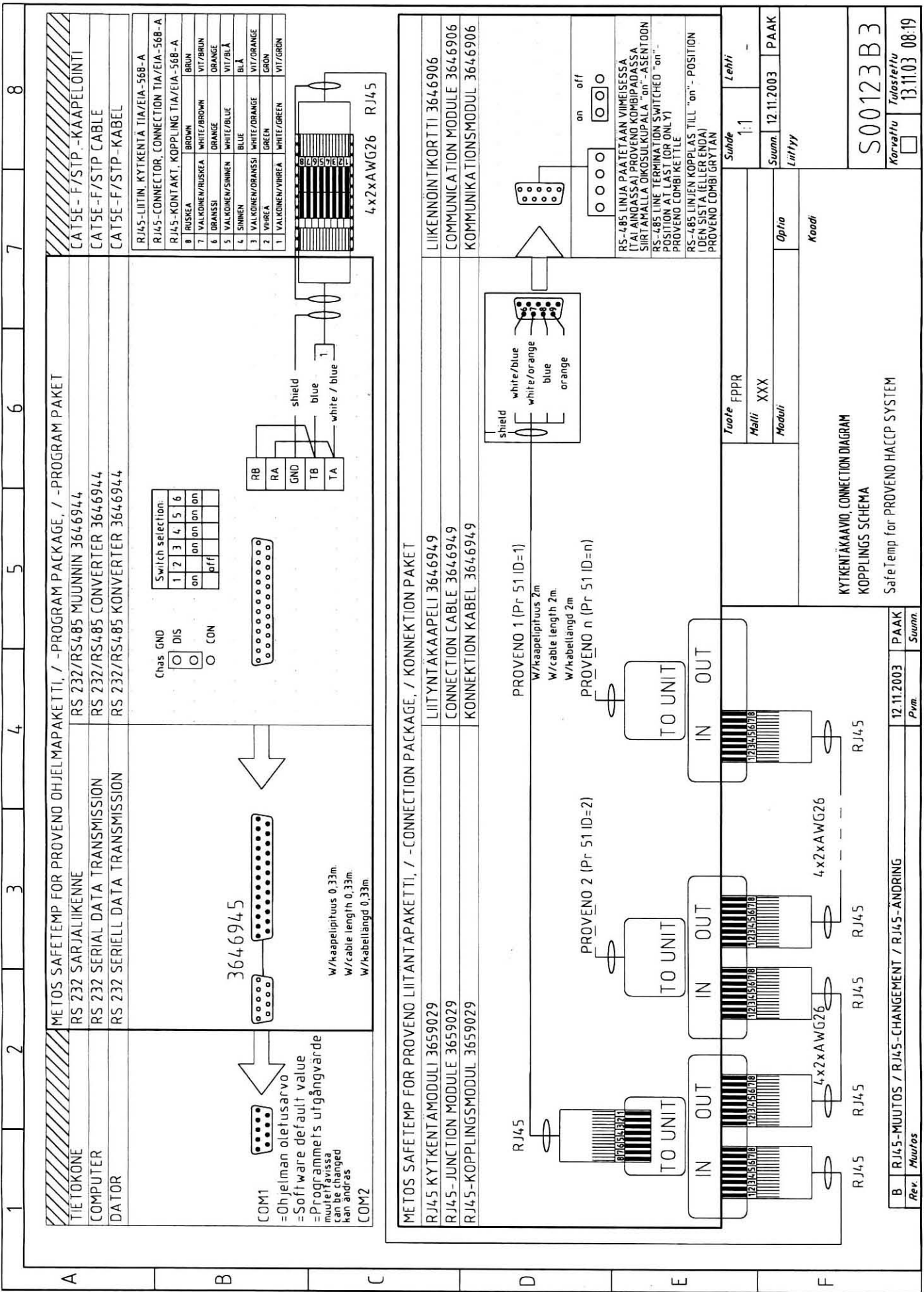

Connection diagram S00123 B3

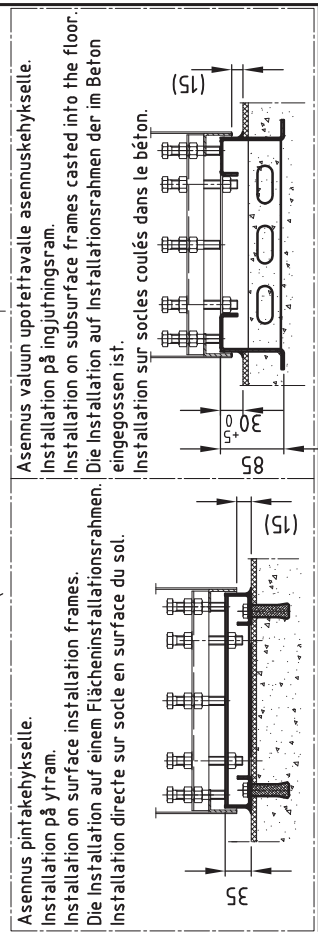
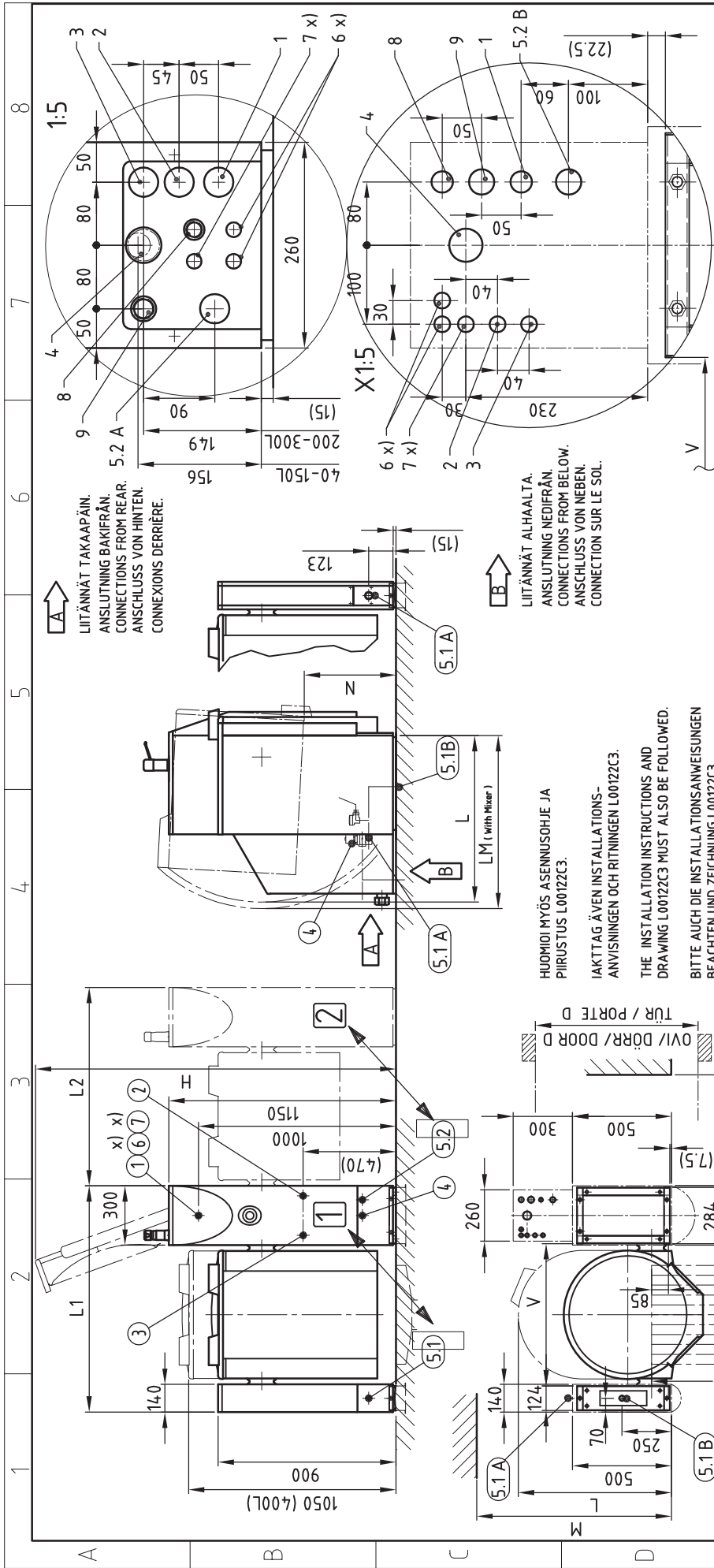

Suide Skala Scale		1:20
Suunn. Scale		roh
L00094G3		
Korvattu Tulostettu		15.05.2009
ASENNUSPIIRUSTUS / HÖYRY INSTALLATIONRITNING / ÅNGA INSATALLATION DRAWING / STEAM		INSTALLATIONSZEICHNUNG / DAMPF DESSUNG / INSTALLATION / VAPEUR
PROVENO FPPR-S		

FPPR	L1	L2	M	L	LM	H	S	T	D	N	V	Ⓢ	Ⓜ	
4.0S	1037	897	900	720	830	1800	800	400	800	515	613	R3/4"	12 KG/H R1/2"	215
6.0S	1037	897	1040	810	910	1800	800	400	800	515	613	R3/4"	18 KG/H R1/2"	225
8.0S	1144	1004	1080	880	930	1850	800	500	820	465	720	R3/4"	24 KG/H R1/2"	245
10.0S	1144	1004	1080	880	930	1850	800	500	820	465	720	R1"	30 KG/H R3/4"	280
15.0S	1350	1210	1010	970	970	1900	800	600	940	460	926	R1"	45 KG/H R3/4"	320
20.0S	1350	1210	1130	1050	1050	1900	800	600	940	460	926	R1 1/4"	60 KG/H R3/4"	360
30.0S	1550	1410	1190	1190	1190	2050	1200	600	1165	450	1126	R1 1/4"	90 KG/H R3/4"	430
40.0S	1550	1410	1190	1190	1190	2050	1200	600	1165	440	1126	R1 1/4"	120 KG/H R3/4"	490

G	Lisätty 400L:n pala	06.05.2009	maso
F	Lisätty vaihtoehtoiset liitännät avat takaa/alhaalta + jäspankkijäähdytys	24.08.2007	maso
E	LM, N IS ADDED. L (40-100) IS CORRECTED (PREVIOUSLY L=LM)	29.11.2004	ROH
D	Teksti siirretty omalle kuvalle L00122A3.	12.05.2004	VMA
C	Lisätty toinen Haccp-kaapeli	12.11.2003	ANP
Rev.	Muutos	Pvm	Suunn.

x) LISÄVARUSTE
TILLÄGGSUTRUSTNING
ACCESSORY
ZUBEHÖR
ACCESSOIRE

HUOMIOI MYÖS ASENNUSOHJE JA
PIIRUSTUS L00122C3.
IÄKTTAG ÄVEN INSTALLATIONS-
ANVISNINGEN OCH RITNINGEN L00122C3.
THE INSTALLATION INSTRUCTIONS AND
DRAWING L00122C3 MUST ALSO BE FOLLOWED.
BITTE AUCH DIE INSTALLATIONSANWEISUNGEN
BEACHTEN UND ZEICHNUNG L00122C3.

NOTER AUSSI DES INSTRUCTIONS
D'INSTALLATION ET DESSIN L00122C3.

LITÄNNÄT TAKAÄPÄIN.
ANSLUTNING BAKIFRÄN.
CONNECTIONS FROM REAR.
ANSCHLUSS VON HINTEN.
CONNEXIONS DERRIÈRE.

LITÄNNÄT ALHAALTA.
ANSLUTNING NEDIFRÄN.
CONNECTIONS FROM BELOW.
ANSCHLUSS VON NEBEN.
CONNECTION SUR LE SOL.

OV / DÖRR / DOOR
TÜR / PORTE D

Installation drawing L00094 G3

1	2	3	4	5	6	7	8
A	<p>1. SÄHKÖLIIANTÄ, VARATTAVA LATTIASTA 15M SÄHKÖKAAPELIA. 2. KYLMÄVESILIITÄNTÄ Ø15 (R1/2"), VARUSTETTAVA TAKAISKU- JA SULKUVENTTIILILLÄ. 3. LÄMMINVESILIITÄNTÄ (MAX 60°C) Ø15, VARUSTETTAVA TAKAISKU- JA SULKUVENTTIILILLÄ. 4. HÖYRYLIITÄNTÄ MAX 1,0 BAR, SYÖTÖLINJIA VARUSTETTAVA TAKAISKU- JA SULKUVENTTIILILLÄ, SUODATTIMELLA, PAINENAILENNUS- JA VAROVENTTIILILLÄ MAX 130°C. 5.1. LAUHDELITÄNTÄ VASEMMAANPUOLEISESSA JALASSA. 5.2. LAUHDELITÄNTÄ OIKEANPUOLEISESSA JALASSA, AINDAATAAN RYHMÄPADOISSA. 6. TIETOLIIKENNEKAPELOINTI (HACCP), VARATTAVA 2 KPL MIN 20 MM PUTKITUSTA. 7. JÄÄPANKIN OHJAUSKAPELLI. VARATTAVA 1 KPL MIN 20 MM PUTKITUSTA. 8. JÄÄPANKKI SISÄIN (R1/2"), MAKS. PAINE 4 BAR, MAKS. VIRTAAMA 24L/MIN. 9. JÄÄPANKKI ULOS (R3/4").</p>						
B	<p>1. ELANSLUTNING, RESERVERA ELKABEL 1,5M FRÅN GOLV 2. KALLVATTENANSLUTNING Ø15 (R1/2"), BÖR FÖRSES MED ENVÄGS- OCH AVSTÄNGNINGSVENTIL. 3. VARMVATTEN (HÖGST 60°C) Ø15, BÖR FÖRSES MED ENVÄGS- OCH AVSTÄNGNINGSVENTIL. 4. ÅNGANSLUTNING MAX 1,0 BAR. ÅNGLEDNINGEN SKALL FÖRSES MED ENVÄGS- OCH AVSTÄNGNINGSVENTIL, FILTER, TRYCKREDUCERINGS- OCH SÄKERHETSVENTIL MAX 130°C. 5.1 KONDENSANSLUTNING I VÄNSTRA STÖDPELAREN. 5.2 KONDENSANSLUTNING I HÖGER STÖDPELAREN, BARA I GRUPP GRYTORNA 6. DATA KABEL (HACCP), 2 ST MIN. 20 MM SKYDDSRÖR BÖR RESERVERAS. 7. STYRKABEL TILL ISVATTENLAGET. 1 ST MIN. 20 MM SKYDDTUB BÖR RESERVERAS. 8. ISVATTEN IN (R1/2"), MAX. TRYCK 4 BAR, MAX FLÖDE 24L/MIN. 9. ISVATTEN UT (R3/4").</p>						
C	<p>1. RESERVE 1,5M OF POWER CABLE ABOVE THE FLOOR LEVEL. 2. COLD WATER CONNECTION Ø15 (R1/2"), ONE-WAY AND SHUT-OFF VALVES MUST BE FITTED. 3. WARM WATER CONNECTION (MAX 60°C) Ø15, ONE-WAY AND SHUT-OFF VALVES MUST BE FITTED. 4. STEAM CONNECTION MAX 1,0 BAR. THE STEAM INLET PIPE HAS TO BE EQUIPPED WITH ONE-WAY AND SHUT-OFF VALVES, FILTER, REDUCTION AND SAFETY VALVE MAX. 130°C. <u>STEAM TEMPERATURE MAX 130°C.</u> 5.1 CONDENS CONNECTION, INSIDE THE LEFT HAND PILLAR FOOT. 5.2 CONDENS CONNECTION, INSIDE THE RIGHT HAND PILLAR FOOT, ONLY IN GROUP KETTLES. 6. DATA CABLE (HACCP), 2 PCS OF MIN. 20 MM COVER TUBES MUST BE RESERVED. 7. CONTROL CABLE TO ICEBANK SYSTEM. 1PC OF MIN. 20 MM COVER TUBE MUST BE RESERVED. 8. ICEWATER IN (R1/2"). MAX PRESSURE 4 BAR, MAX. FLOW 24L/MIN. 9. ICEWATER OUT (R3/4").</p>						
D	<p>1. ELEKTROANSCHLUSS, 1,5M ELKABEL ÜBER FUSSBODEN FREILASSEN. 2. KALTWASSERANSCHLUSS Ø15 (R1/2"), SOLL MIT EINEM RÜCKSCHLAGVENTIL UND ABSPERRVENTIL VERSEHEN WERDEN. 3. WARMWASSERANSCHLUSS (ALLER HÖCHSTENS 60°C) Ø15, SOLL MIT EINEM RÜCKSCHLAGVENTIL UND ABSPERRVENTIL VERSEHEN WERDEN. 4. DAMPFEINLASS MAX. 1,0 BAR. ZUBERINGERLINIE SOLL MIT EINEM RÜCKSCHLAGVENTIL UND ABSPERRVENTIL, FILTER, DRUCKVERMINDERUNGSVENTIL UND SICHERHEITSVENTIL MAX. 1,5 BAR VERSEHEN WERDEN. <u>DAMP TEMPERATUR MAX 130°C.</u> 5.1 KONDENSWASSERABLASS, IN DER LINKEN STÜTZKONSOLE. 5.2 KONDENSWASSERABLASS, IN DER RECHTEN STÜTZKONSOLE. NUR BEI GRUPPENKESSELN. 6. DATENÜBERTRAGUNGSKABEL (HACCP), 2 x MIND. 20MM VERROHRUNG ZU RESERVIEREN. 7. STEUERUNGSKABEL ZUM EISERZEUGER, 1 x MIND. 20 MM VERROHRUNG ZU RESERVIEREN. 8. EISERZEUGER EINLASS (R1/2"), MAX. DRUCK 4 BAR, MAX. FLUT 24L/MIN. 9. EISERZEUGER AUSLASS (R3/4").</p>						
E	<p>1. BRANCHEMENT ÉLECTRIQUE 1,5M DU CÂBLAGE SUR LE SOL À RÉSERVER. 2. CONNECTION D'EAU FROIDE Ø15 (R1/2"), DOIVENT ÊTRE MUNIES DE SOUPAPE DE RETENUE ET VANNES D'ARRÊT. 3. CONNECTION D'EAU CHAUDE (AU MAXIMUM 60°C) Ø15, DOIVENT ÊTRE MUNIES DE SOUPAPE DE RETENUE ET VANNES D'ARRÊT. 4. BRANCHEMENT VAPEUR MAX. 1,0 BAR. LIGNE D'ALIMENTATION DOIVENT ÊTRE MUNIES DE SOUPAPE DE RETENUE ET VANNES D'ARRÊT, FILTRE, VANNE DE DÉCOMPRESSION ET DE SOUPAPE DE SÉCURITÉ MAX 1,5 BAR. <u>TEMPÉRATURE DE VAPEUR MAX 130°C.</u> 5.1 BRANCHEMENT CONDENSAT. DANS LE PILLIER GAUCHE. 5.2 BRANCHEMENT CONDENSAT. DANS LE PILLIER DROITE. SEULEMENT MARMITES DE GROUPE. 6. CÂBLAGE INFORMATIQUE (HACCP), A RÉSERVER. TUYAUX 2 x à MIN 20 MM. 7. CÂBLAGE POUR LA TRANSMISSION DE CENTRALE EAU GLACÉE. A RÉSERVER. TUYAUX 1 x à MIN 20 MM. 8. DÉPART CENTRALE EAU GLACÉE (R1/2"). MAX. PRESSION 4 BAR. MAX. FLUX 24L/MIN. 9. RETOUR CENTRALE EAU GLACÉE (R3/4").</p>						
F	<p>x) LISÄVARUSTE TILLÄGGSUTRUSTNING ACCESSORY ZUBEHÖR ACCESSOIRE</p>						
		Tuote Produkt Product		PROVENO FPPR-S		Suhte Skala Scale Suunn. vma	
		TEKSTIOSA / HÖYRY TEXT DEL / ÅNGA TEXT PART / STEAM		TEXT / DAMPF TEXT / VAPEUR CONN.-->DWG L00094F3		L00122 C3 Tuloslehti 25.01.2010	
C		Eritelty tuki- ja toimijalan lauhteenpoistot.		06.05.2009		maso	
B		Lisäilty jäähdytys.		15.10.2007		maso	
		Rev. / Muutos		Pvm.		Suunn.	

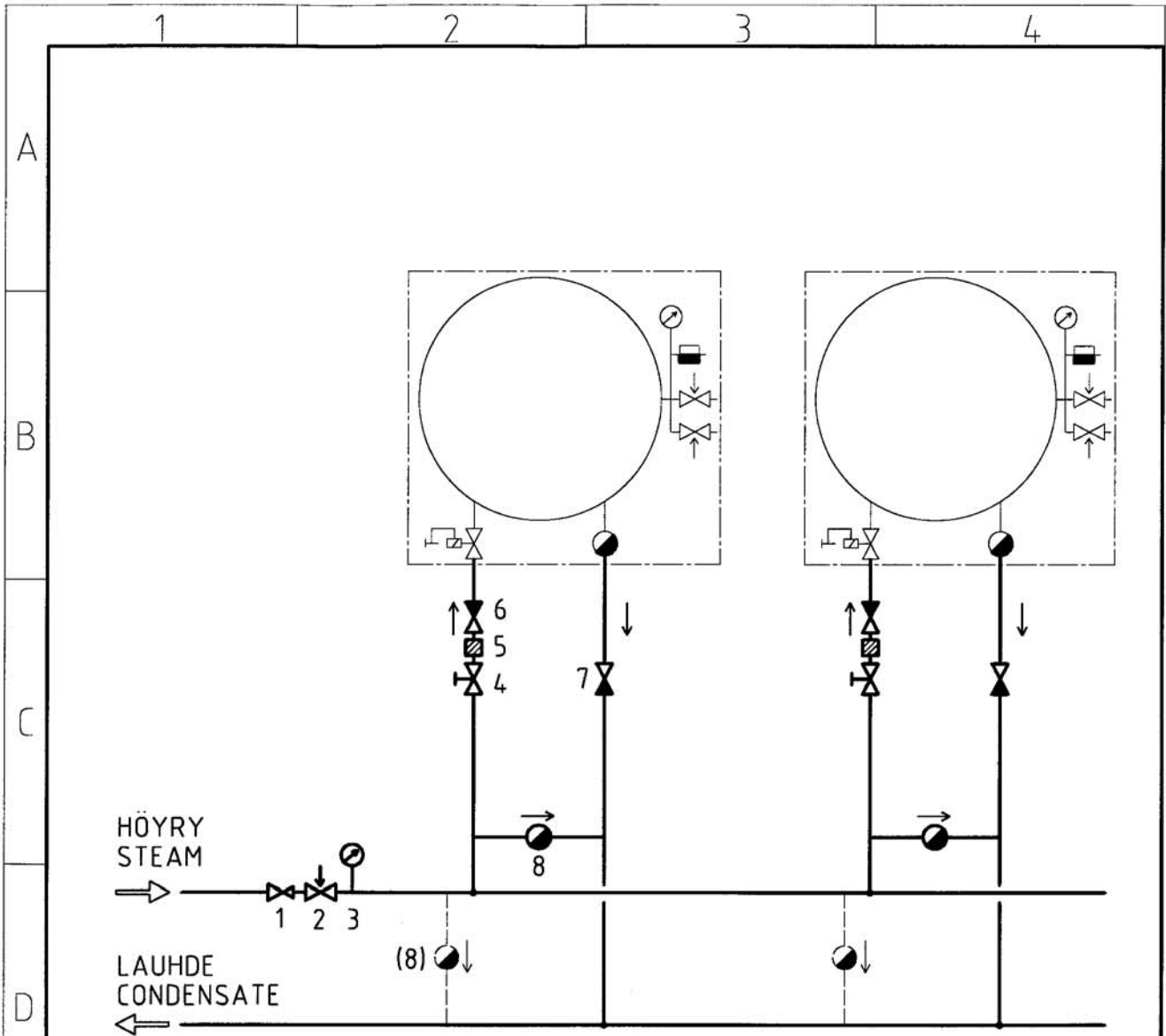

1. Paineenalennusventtiili
2. Varoventtiili
3. Painemittari
4. Sulkuventtiili
5. Suodatin
6. Takaiskuventtiili (mikäli kyseessä on jäähdytyksellä varustettu laite)
7. Takaiskuventtiili (0 bar)
8. Lauhteenerotin

1. Pressure reduction valve
2. Safety valve
3. Manometer
4. Shut-off valve
5. Filter
6. Non-return valve (in case of a cooling equipped appliance)
7. Non-return valve (0 bar)
8. Condensate remover

F	Tuote		Suhde			
	Malli		1:1			
	Moduli		Optio		Toleranssittomat mitat LT06031	
					Suunn.	08.01.2004 ROH
HÖYRYNSYÖTTÖ SUOSITUS			Koodi		000030A4	
STEAM SUPPLY RECOMMENDATIONS						
			Korvattu		Tulostettu	
			<input type="checkbox"/>		08.01.04 15:34	

Technical specifications

Item	Type	Access- sory	Specification
Overall dimensions incl. support pillar WxDxH	40,60		1037x800x900/1150 mm
Overall dimensions incl. support pillar WxDxH	80,100		1144x800x900/1150 mm
Overall dimensions incl. support pillar WxDxH	150,200		1350x920x900/1150 mm
Overall dimensions incl. support pillar WxDxH	300,400		1550x1160x900/1150 mm
Support pillar dimensions LxDxH			140x500x900 mm
Distance needed behind the kettle	40		830 mm
Distance needed behind the kettle	60		910 mm
Distance needed behind the kettle	80,100		930 mm
Distance needed behind the kettle	150		970 mm
Distance needed behind the kettle	200		1050 mm
Distance needed behind the kettle	300,400		1190 mm
Tilting height from outer shell to floor	40		515 mm
Tilting height from outer shell to floor	60		515 mm
Tilting height from outer shell to floor	80,100		465 mm
Tilting height from outer shell to floor	150,200		460 mm
Tilting height from outer shell to floor	300		450 mm
Tilting height from outer shell to floor	400		440 mm
Maximum height of cover	40,60		1800 mm
Maximum height of cover	80,100		1850 mm
Maximum height of cover	150,200,300		1900 mm
Maximum height of cover	400		2050 mm
Distance needed for service	40,60		400 mm
Distance needed for service	80,100		500 mm
Distance needed for service	150,200,300,400		600 mm
Inner diameter	40, 60		472 mm
Inner diameter	80,100		545 mm
Inner diameter	150,200		744 mm
Inner diameter	300,400		944 mm
Material of inner jacket and bottom			Acid proof stainless steel AISI 316
Other parts of the kettle			Stainless steel AISI 304
Weight with package	40		260 kg
Weight with package	60		270 kg
Weight with package	80		295 kg
Weight with package	100		325 kg
Weight with package	150		380 kg
Weight with package	200		410 kg
Weight with package	300		490 kg
Weight with package	400		550 kg
Weight	40		215 kg
Weight	60		225 kg
Weight	80		245 kg
Weight	100		280 kg
Weight	150		320 kg
Weight	200		360 kg

Technical specifications

Item	Type	Access- sory	Specification
Weight	300		430 kg
Weight	400		490 kg
Transport volume	40,60		1,64
Transport volume	80,100		1,82
Transport volume	150,200		2,44
Transport volume	300,400		3,37
Mixer power	40,60,80,100	M,MC3P	0,75 kW
Mixer power	150,200,300	M,MC3P	1,5 kW
Mixer power	400	M,MC3P	2,2 kW
Electricity connections			see Wiring diagram
Water connections			see Installation drawing
Steam and condense connections			see Installation drawing
Sound level of the appliance measured 1m straight in front of the appliance and at a height of 1,5m			<70 dB(A)
Weight of mixing tool	40	M,MC3P	2,8 kg
Weight of mixing tool	60	M,MC3P	4,2 kg
Weight of mixing tool	80	M,MC3P	4,2 kg
Weight of mixing tool	100	M,MC3P	4,5 kg
Weight of mixing tool	150	M,MC3P	4,7 kg
Weight of mixing tool	200	M,MC3P	5,5 kg
Weight of mixing tool	300	M,MC3P	6,5 kg
Weight of mixing tool	400	M,MC3P	11,2 kg
Number of scrapers	40	M,MC3P	1
Number of scrapers	60,80	M,MC3P	2
Number of scrapers	100,150	M,MC3P	3
Number of scrapers	200,300	M,MC3P	4
Number of scrapers	400	M,MC3P	5
Emptying valve			
Mixer M			
AutoPack A			Timer and automatic water filling
Manual cooling C1			
Cool C2			Timer and automatic cooling
Icebank cooling C3		MC3P	Timer and automatic icebank cooling
Cool Pro P			Timer, automatic water filling, automatic cooling, EasyRun programming and HACCP readiness
Wall mounted W	40,60,80,100,150		
Free standing F	40,60,80,100		

S=PROVENO S

40=40 l, 60=60 l, 80=80 l, 100=100 l, 150=150 l, 200=200 l, 300=300 l, 400=400 l

MA=MIXER, AUTOPACK, MC1=MIXER, MANUAL COOLING, MAC1=MIXER, AUTOPACK, MANUAL COOLING, MC2=MIXER, COOL, MC2P=MIXER, COOL PRO, MC3P=MIXER, COOL PRO, ICEBANK COOLING, ER=EASYRUN, R=MIXING WHILE TILTING, D=EMPTYING VALVE, X=SPECIAL MODEL

A=3/N/PE~400/230V 50Hz, C=3/N/PE~380/220V 50Hz, D=3/PE~200V 50-60Hz, F=2/PE 220-240V 50Hz, G=3/N/PE~415/240V 50Hz, H=3/PE~230V 50Hz, I=3/PE~220V 60Hz, J=3/PE~380 50Hz, K=3/PE~400V 50Hz, L=3/PE~415V 50Hz, M=3/PE~440V 60Hz, N=3/PE~460V 60Hz, O=3/PE~480V 60Hz, P=1/N/PE~220-240V 50Hz, R=2/PE~220-230V 60Hz

Valmistajan nimi / Tillverkarens namn / Manufacturer's name

METOS OY AB

Osoite / Adress / Adress

04220 KERAVA
FINLAND

Vakuuttaa, että seuraava tuote / Försäkrar att följande produkt / Declare that the following product

Nimi, tyyppi tai malli / Namn, typ eller modell / Name, type or model

Kombipatasarjat / Kombigrytsserierna / Combikettle series METOS / HACKMAN PROVENO, CULINO COMBI ja / och / and VIKING COMBI sähkö- tai hörylämmitteinen / el- eller ånguppvärmd / electrically or steam heated.

Mallit / Modeller / Models : 40, 60, 80, 100, 150, 200, 300, 400

Varustepaketit / Optionspaket / Option sets: Basic, Combi, Combi Pro, Cool, Cool Pro, Chill Pro

on seuraavien direktiivien asiaankuuluvien säännösten mukainen / överensstämmer med tillämpliga bestämmelser i följande direktiv / is in conformity with the relevant provisions of the following directives

MD 2006/42/EC, LVD 2006/95/EC, EMC 2004/108/EC, RoHS 2002/95/EC, WEEE 2002/96/EC

PED 97/23/EC, moduulit / modulerna / modules B1 + D

- SEP: 40 – 60 höyry/ånga/steam

- Cat I: 40 – 60 sähkö/el/electric, 80 – 400 höyry/ånga/steam

- Cat II: 80 – 400 sähkö/el/electric

HUOM: PED 97/23/EY artiklan 3 kohdan 3 mukaisesti vaatimustenmukaisuusvakuutus ja CE – merkintä ei koske SEP luokiteltuja laitteita.

OBS: Enligt PED 97/23/EG artikel 3 paragraf 3 gäller försäkran om överensstämmelse och CE –märkningen ej produkter i SEP kategorin.

ATT: According to PED 97/23/EC article 3 paragraph 3 the declaration of conformity and the CE –marking does not apply to SEP category products.

ja lisäksi vakuuttaa, että seuraavia yhdenmukaistettuja standardeja (tai niiden osia/kohtia) on sovellettu / och försäkrar dessutom att följande harmoniserade standarder (eller delar/paragrafer) har använts / and furthermore declares that the following harmonised standards (or parts/clauses) have been used

EN ISO 12100-1, EN ISO 12100-2, EN ISO 13857
EN 61000-6-1, EN 61000-6-3

ja lisäksi vakuuttaa, että seuraavia muita standardeja (tai niiden osia/kohtia) on sovellettu / och försäkrar dessutom att följande andra standarder (eller delar/paragrafer) har använts / and furthermore we declare that the following other standards (or parts/clauses) have been used

EN 60204-1, EN 60335-1, EN 60335-2-47
EN 13886

Tuotteen suunnitelmatarkastustodistus ja laatujärjestelmää valvova ilmoitettu laitos (vain painelaitteet)
Produktens konstruktionskontrollcertifikat och anmält organ, som övervakar kvalitetssystemet (endast tryckkärl)
Product design examination certificate and the notified body supervising the quality system (only pressure vessels)

RS 489-02 + Quality system
Inspecta Tarkastus Oy, Helsinki, Finland
0424

DA 30289-2008 (400E), 30317-2009 (400S)
Polartest Oy, Vantaa, Finland
0875

Alla mainittu henkilö on valtuutettu kokoamaan teknisen tiedoston / Nedan nämda person är bemyndigad att sammanställa den tekniska dokumentfilen / The person mentioned below is authorized to compile the technical file

Rainer Keto **Metos Oy Ab, Ahjonkaarre, 04220 Kerava, Finland**

Antopaikka ja päivä / Utfärdad på ort och datum / Place and date of issue

KERAVA **20.1.2010**

Valtuutetun henkilön nimi ja asema / Bemyndigad persons namn och befattning / Name and title of authorized person



Pekka Mönkkönen – Director of Business Unit



Pasi Karhunen - Manager