

# metos

## BULK BREWING COFFEE MACHINE METOS COMBI

CB

TYPE: 5, 1x5R, 1x5L, 2x5, 10, 1x10R, 1x10L, 2x10, 20, 1x20R, 1x20L, 2x20

---

### User Manual

---



---

S/N:

Rev.: 2.2

---



Dear Customer,

Congratulations on deciding to choose a Metos appliance for your kitchen activities. You made an excellent choice. We will do our best to make you a satisfied Metos customer like thousands of customers we have around the world.

Please read this manual carefully. You will learn correct, safe and efficient working methods in order to get the best possible benefit from the appliance. The instructions and hints in this manual will give you a quick and easy start, and you will soon note how nice it is to use the Metos equipment.

All rights are reserved for technical changes.

You will find the main technical data on the rating plate fixed to the equipment. When you need service or technical help, please let us know the serial number shown on the rating plate. This will make it easier to provide you with correct service.

For your convenience, space is provided below for you to record your local Metos service contact information.

METOS TEAM

Metos service phone number:.....

Contact person:.....



|   |           |
|---|-----------|
| <b>1. General .....</b>   | <b>1</b>  |
| 1.1 Symbols used in the manual .....  | 1         |
| 1.2 Symbols used on the appliance .....   | 1         |
| 1.3 Checking the relationship of the appliance and the manual .....                       | 1         |
| <b>2. Safety .....</b>  | <b>2</b>  |
| 2.1 Warnings .....  | 2         |
| 2.1.1 Installation .....  | 2         |
| 2.1.2 Use .....   | 2         |
| 2.1.3 Maintenance and troubleshooting .....   | 2         |
| 2.2 Safeguards .....  | 3         |
| 2.2.1 On/off switch .....   | 3         |
| 2.2.2 STOP button .....   | 3         |
| 2.2.3 Swivel arm and container detection .....  | 3         |
| 2.2.4 Dry-boil protection .....   | 3         |
| 2.2.5 Warning indication display .....  | 3         |
| 2.3 Disposal of the appliance .....   | 4         |
| <b>3. Functional description .....</b>  | <b>5</b>  |
| 3.1 General .....   | 5         |
| 3.2 Models .....  | 5         |
| 3.3 Application of the appliance .....  | 6         |
| 3.3.1 Prohibited use/Use for other purposes .....   | 6         |
| 3.4 Construction [1x5, 1x10, 1x20, 2x5, 2x10, 2x20] .....                                 | 7         |
| 3.5 Construction [5, 10, 20] .....  | 9         |
| 3.6 Operating switches and indicator lights [5, 10, 20, 1x5, 1x10, 1x20, 2x5, 2x10, 2x20] | 11        |
| 3.7 Display [5, 10, 20, 1x5, 1x10, 1x20, 2x5, 2x10, 2x20] .....                           | 12        |
| 3.8 Error reporting symbols .....   | 12        |
| <b>4. Operation instructions .....</b>  | <b>13</b> |
| 4.1 Before using the appliance .....  | 13        |
| 4.1.1 Flushing the flow heater system .....   | 13        |
| 4.1.2 First settings operator menu .....  | 14        |
| 4.2 Operation procedures .....  | 14        |
| 4.2.1 Brewing coffee .....  | 15        |
| 4.2.2 Brewing tea .....   | 17        |
| 4.2.3 Timer function .....  | 17        |
| 4.2.4 The operator menu [5, 1x5, 10, 1x10, 20, 1x20, 2x5, 2x10, 2x20] .....               | 19        |
| 4.2.5 Menu functions .....  | 19        |

---

|  |           |
|--|-----------|
| 4.2.6 Settings step by step .....                                    | 20        |
| 4.3 After use .....  | 35        |
| 4.3.1 Cleaning .....   | 35        |
| 4.3.2 Periodic descaling activities .....                            | 37        |
| <b>5. Installation .....</b>   | <b>39</b> |
| 5.1 General .....  | 39        |
| 5.2 Unpacking [1x5, 1x10, 1x20, 2x5, 2x10, 2x20] .....               | 40        |
| 5.3 Unpacking [5, 10, 20] .....                                      | 41        |
| 5.4 Preparation for positioning .....                                | 41        |
| 5.5 Water connection .....   | 42        |
| 5.5.1 Water treatment .....  | 42        |
| 5.6 Water drainage .....   | 42        |
| 5.7 Electrical connection .....                                      | 43        |
| 5.8 Connection on a counter [1x5, 1x10, 1x20, 2x5, 2x10, 2x20] ..... | 44        |
| 5.9 Mounting on a wall [5, 10, 20] .....                             | 44        |
| <b>6. Troubleshooting .....</b>                                      | <b>46</b> |
| <b>7. Technical specifications .....</b>                             | <b>47</b> |

# 1. General

Carefully read the instructions in this manual as they contain important information regarding proper, efficient and safe installation, use and maintenance of the appliance.

Keep this manual in a safe place for eventual use by other operators of the appliance.

The installation of this appliance must be carried out in accordance with the manufacturer's instructions and following local regulations. The connection of the appliance to the electric and water supply must be carried out by qualified persons only.

Persons using this appliance should be specifically trained in its operation.

Switch off the appliance in the case of failure or malfunction. The periodical function checks requested in the manual must be carried out according to the instructions. Have the appliance serviced by a technically qualified person authorized by the manufacturer and using original spare parts.

Not complying with the above may put the safety of the appliance in danger.

## 1.1 Symbols used in the manual



This symbol informs about a situation where a safety risk might be at hand. Given instructions are mandatory in order to prevent injury.



This symbol informs about the right way to perform in order to prevent bad results, appliance damage or hazardous situations.



This symbol informs about recommendations and hints that help to get the best performance out of the appliance.

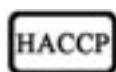

This symbol informs about a function that has to be taken into account in self-control.

## 1.2 Symbols used on the appliance



This symbol on a part informs about electrical terminals behind the part. The removal of the part must be carried out by qualified persons only.

## 1.3 Checking the relationship of the appliance and the manual

The rating plate of the appliance indicates the serial number of the appliance. If the manuals are missing, it is possible to order new ones from the manufacturer or the local representative. When ordering new manuals it is essential to quote the serial number shown on the rating plate.

## 2. Safety

### 2.1 Warnings

#### 2.1.1 Installation

- Place the appliance at buffet height and on a firm, level base, in such a way that it can be connected to the water supply and power supply.
- Connect the appliance to an earthed wall socket.
- Position the appliance in such a way that no damage can be caused if it leaks.
- Do not tilt the appliance, always position and move the appliance upright.
- Connect an overflow pipe to the drainage tube.
- Water always remains in the heating system: for this reason the appliance must not be placed in an area where the temperature can fall below freezing point.
- When installing the appliance, always observe the local rules and use approved materials and parts.
- The Installation chapter must again be followed when repositioning the appliance.
- Connect the appliance to the cold water mains.

#### 2.1.2 Use

- Inspect the appliance before using it and check it for damage.
- Never submerge or spray the appliance.
- Do not press the buttons with a sharp object.
- Protect the controls against dirt and grease.
- During use some parts will become very hot.
- Do not position the container on open fire, or hot plate.
- First disconnect the electric cable before transporting the container.
- It is advisable to take the plug out of the socket and close the water tap if the appliance is not going to be used for longer periods of time

#### 2.1.3 Maintenance and troubleshooting

- Observe the descaling intervals indicated by the descaling indicator symbol.
- Overdue maintenance to the heating system can result in high repair costs and annulment of the guarantee.
- Do not leave the appliance unattended when maintenance is being performed.



- When descaling the appliance, it is advisable to wear safety glasses and protective gloves.
- Wash your hands after descaling.
- Have all repairs carried out by a qualified technician.
- The plug must be taken out of the socket if the appliance has to be opened for cleaning or repairs.

## 2.2 Safeguards

The appliance is fitted with the following safe guards

### 2.2.1 On/off switch

The on/off switch is used to switch the appliance on and off. Remember that the appliance can still be live after being switched off! For this reason you should always remove the plug from the socket to render the appliance voltage-free.

### 2.2.2 STOP button

The coffee making process can be interrupted at any point using the STOP button located on the control panel.

### 2.2.3 Swivel arm and container detection

This appliance is equipped with a safety device through which it is only possible to start the brewing process if the swivel arm and container are in the correct position. If the swivel arm and/or container are moved out of position during the brewing process, the brewing process is interrupted, a swivel arm and/or container symbol appears in the display and there is a sound signal (2x short). Once the positioning fault has been resolved the brewing process can be restored by pressing the START button.

### 2.2.4 Dry-boil protection

This appliance is equipped with a dry-boil protection. This protection triggers if the heating elements overheat owing to a fault. Once the fault has been resolved, the dry-boil protection can be reset at the outside of the appliance. The most common cause of the dry-boil protection being triggered is not descaling the heating system in time.

### 2.2.5 Warning indication display

A technical fault is reported by displaying an error code in the display. The relevant problem can be localised and resolved with the help of this code. In this case see chapter 13-Troubleshooting.

## 2.3 Disposal of the appliance

No appliance lasts forever. When the time comes to discard your appliance it will usually be possible to return it to your dealer. If this is not the case, ask your municipal council about the alternatives for recycling the materials. All plastic parts have been given standard codes. The parts of the appliance such as the printed circuit board and accompanying parts form electrical and electronic waste. The metal body is made of stainless steel and can be completely dismantled.

## 3. Functional description

### 3.1 General

The ComBi-line 5 - 20 is a professional coffee maker, equipped with a continuous flow heater. It is very easy to use. The user can choose from a number of fixed set amounts via a control panel with a graphic display which also offers information about the current process of the appliance. Specific requirements and wishes concerning brewing quantity, etc. can be accessed and programmed by the operator via a PIN. The operator also has the possibility of reading counters and activating a descaling program.

### 3.2 Models

This manual covers the following coffeemakers of the ComBi-line range:

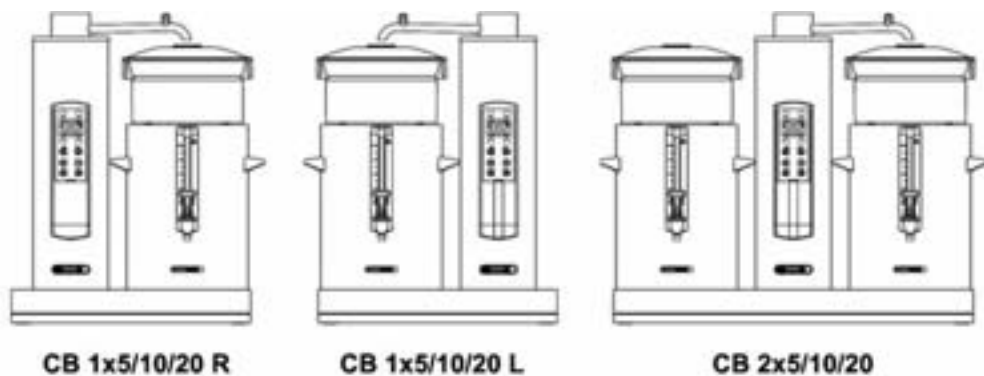

### **3.3 Application of the appliance**

#### **3.3.1 Prohibited use/Use for other purposes**

This machine can only be used for brewing and distributing coffee and/or tea. The use of the appliance for other purposes is not permitted and may be hazardous. The manufacturer cannot be held liable for losses caused by using the appliance for purposes other than those indicated here or by incorrect use.

## Functional description

### 3.4 Construction [1x5, 1x10, 1x20, 2x5, 2x10, 2x20]

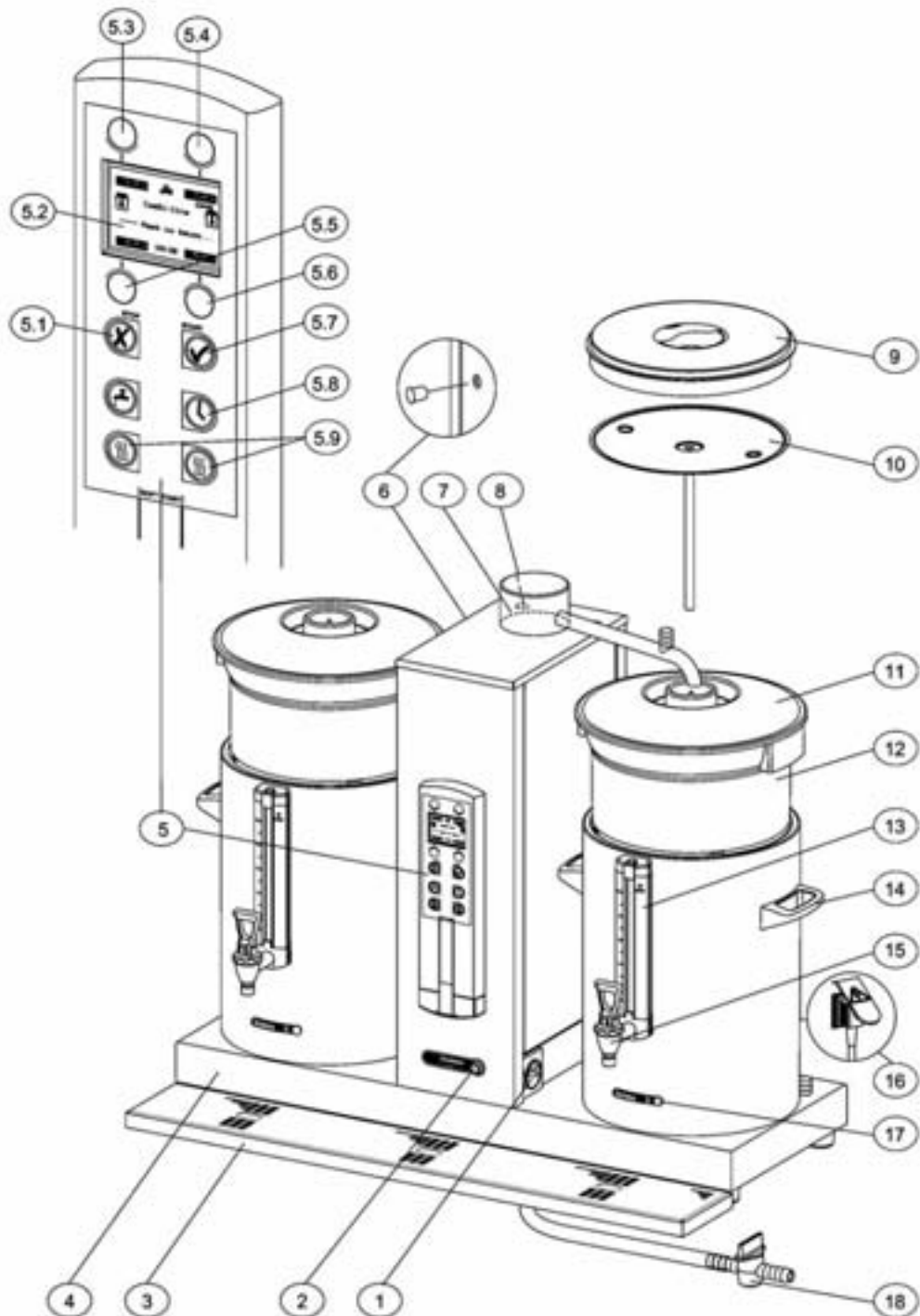

## Functional description

---

1. Socket L/R for container heating
2. ON/OFF switch coffee system
3. Drip tray with grid
4. Base plate
5. Control panel
  - 5.1 STOP button / Back button (without changing)
  - 5.2 Illuminated display
  - 5.3 Selection button brew volume 1
  - 5.4 Selection button brew volume 2
  - 5.5 Selection button brew volume 3
  - 5.6 Selection button brew volume 4
  - 5.7 START button / Accept button (save)
  - 5.8 Timer button
  - 5.9 On/Off button container heating L/R
6. Dry-boil protection
7. Swivel arm
8. Descale filling opening coffee brewing system
9. Insulated lid
10. Blender - transport disk
11. Water distributor lid
12. Basket filter
13. Integrated gauge glass
14. Handle
15. Coffee tap
16. Socket with splash protection
17. Pilot light
18. Drain hose coffee brewing system

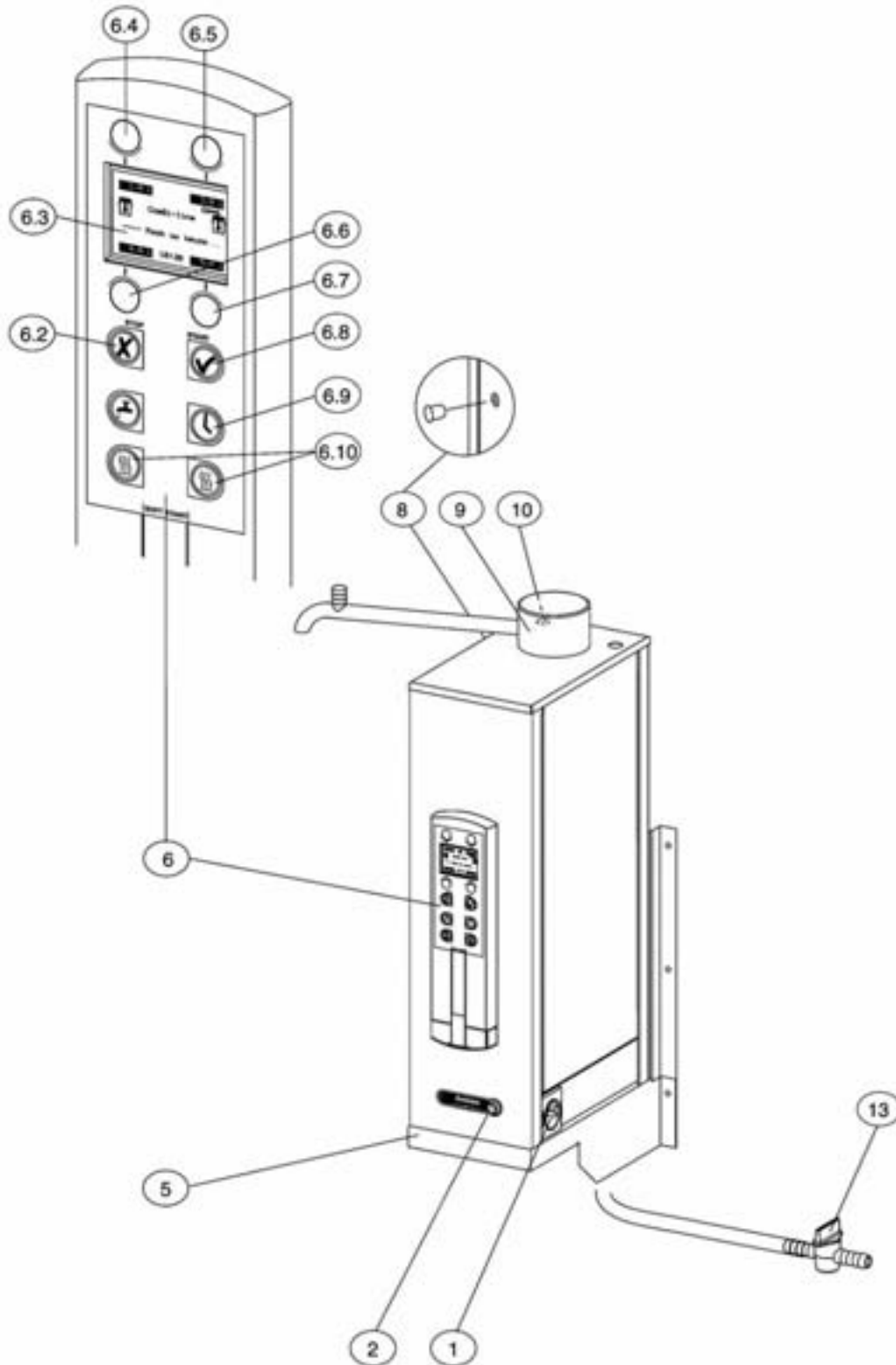
**Functional description****3.5 Construction [5, 10, 20]**

## Functional description

---

1. Socket L/R for container heating
2. ON/OFF switch coffee system
5. Wall bracket
6. Control panel
  - 6.2 STOP button / Back button (without changing)
  - 6.3 Illuminated display
  - 6.4 Selection button brew volume 1
  - 6.5 Selection button brew volume 2
  - 6.6 Selection button brew volume 3
  - 6.7 Selection button brew volume 4
  - 6.8 START button / Accept button (save)
  - 6.9 Timer button
  - 6.10 On/Off button container heating L/R
8. Dry boil protection coffee brewing system
9. Swivel arm
10. Descale filling coffee brewing system
13. Drain hose coffee brewing system









## Functional description

### 3.6 Operating switches and indicator lights [5, 10, 20, 1x5, 1x10, 1x20, 2x5, 2x10, 2x20]

|   |  |  |  |
|---|--|--|--|
| A |  | Selection buttons (4x) The selection buttons are used to select the standard brewing amount. The chosen amount confirmed using the display and can be increased or decreased using the same selection buttons, as required.  |  |
| B |  | STOP button Use the STOP button to cancel a selection or to (emergency) stop a process. An emergency stop results in the process being lost, so it must be executed again. This button can also be used as a cancellation button if the operator menu is activated.              |  |
| C |  | On/Off-switch This switch is used to turn the coffee making system ON (I) or OFF (O).  |  |
| D |  | Display The display informs the user about the status of the most important functions of the appliance.  |  |
| E |  | START button Use the START button to start a brewing process. First choose the brewing amount with one of the selection buttons. This button can also be used as a confirmation button if the operator menu is activated.  |  |
| F |  | Timer button Use the timer button to program the brewing process for use at a later point of time.   |  |
| G |  | Container heating buttons (2x) Use the container heating button to switch the power sockets that are on the side of the column ON/OFF. ATTENTION: Only use the power sockets for the container heating, do not connect any other electrical appliances. (Maximum capacity 100W). |  |
| H |  | Power socket   |  |



## Functional description

### 3.7 Display [5, 10, 20, 1x5, 1x10, 1x20, 2x5, 2x10, 2x20]

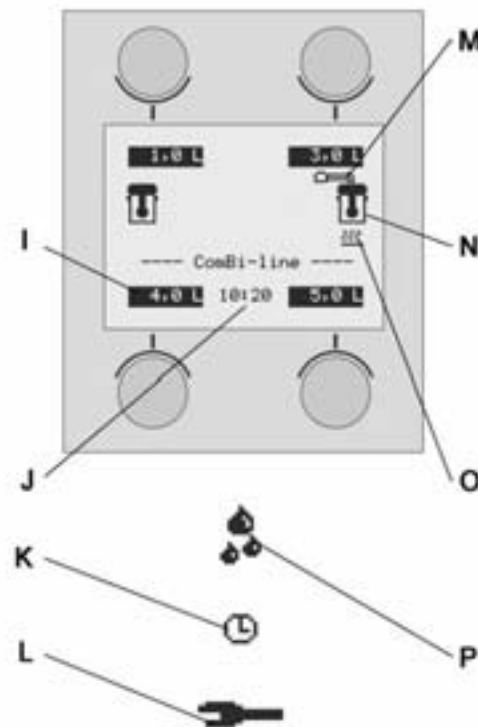
|   |   |   |
|---|---|---|
| I |   | Brew volume (4x)Each selection button (4x) displays a pre-programmed brewing amount. The amounts can be set completely as required via the settings menu.     |
| J |   | ClockReal time indicator  |
| K |    | Timer; (flashing)The timer function is activated.   |
| L |    | Scale indicatorOne of the systems must be descaled at the first opportunity. Look up 'descaling' in the operator menu.  |
| M |    | Swivel arm in positionThe swivel arm is in the correct position above a filter. If the swivel arm is moved away the symbol disappears from the display.       |
| N |    | Container in positionThe coffee container with filter unit is in the correct position. If the container is taken away the symbol disappears from the display. |
| O |    | Container heatingThe heating of the coffee container is switched on. If the heating is switched off the symbol disappears from the display.                   |
| P |  | Leaking outThe dripping symbol is displayed if the hot water dosing is stopped and the filter unit is leaking.  |

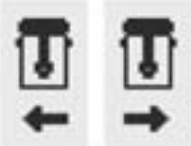
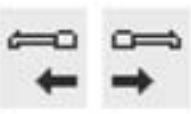
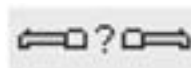

### 3.8 Error reporting symbols

|   |   |
|---|---|
|  | Container position failureThis symbol appears in the display if the coffee container gets out of position during a brewing process. The arrow shows on which side the problem occurs.   |
|  | Swivel arm not in positionThis symbol appears in the display if the swivel arm gets out of position during a making process. The arrow shows on which side the problem occurs.  |
|  | Swivel arm not in position for new brewing process This symbol appears in the display if a brewing process is started and there is (still) no swivel arm in position above the filter unit.   |
|  | Press START buttonThis symbol appears after the swivel arm and/or container fault has been resolved. For your own safety the start button must always be pressed again. If this report is responded to within 10 minutes the brewing process will restart and be completed. |
|  | If the START button is pressed only after 10 minutes, a cross symbol with a flashing clock appears in order to indicate that the brewing process can no longer be restored and should be considered lost.   |

## 4. Operation instructions

### 4.1 Before using the appliance

When used for the first time the appliance works according to the standard factory settings.

The various settings can be altered by trained, authorized personnel. See “Operator menu”.

This chapter will explain the coffee brewing and hot water system process.

- when the appliance is used for the first time.
- when the appliance has not been used for more than 1 week, for example after a holiday period.

#### 4.1.1 Flushing the flow heater system

1. Open the water tap and check if the swivel connections are not leaking.
2. Put the cable with inlet plug into the back of the container and insert the plug into the socket of the flow water heater (fig. 1-1).
3. Check if the containers are positioned correctly, with a filter unit (still without coffee), and position the swivel arm above the centre of the filter.
4. Switch the appliance on by putting the ON/OFF switch (fig. 1-2) in position I, the display (fig. 1-5.2) lights up and you will hear a beeping sound. Then the display will indicate the standard choices.
5. Press selection button 2 (fig. 1-5.4) and confirm your choice by pressing the START button (fig. 1-5.7). The coffee system starts filling and the brewing process starts. In the display appears the text: BREWING. With the STOP button (fig. 1-5.1) the brewing process can be interrupted at any moment. When the watersupply stops coming out of the swivel arm, you will hear a beeping sound (1x short). In the display appears the text: LEAKING. The leaking time is set as standard to approx. 5 minutes, and its ending is indicated by a beeping sound (3x short).
6. Empty the container with the drainage tap (fig. 1-15).
7. Position the swivel arm above the other filter and follow the above procedure once again if the model is equipped with two containers.
8. Once the container is empty the coffee maker is ready for use.

## 4.1.2 First settings operator menu

The following details are set in the operator menu immediately after being used for the first time. Please note: The default language setting is English. To gain access to the operator menu system settings see chapter “The operator menu”.

System settings (Systeminstellungen) (menu 2)

2.0 Language

2.1 Time

2.2 Date

Coffee settings (menu 3)

3.9 Descale indicator

3.10 Coffee dosing

## 4.2 Operation procedures

This chapter describes the daily use of the appliance by partly qualified personnel. When the machine is used for the first time, it works in accordance with the standard factory settings. The different settings can be changed later by trained, qualified personnel. See “The operator menu” for more details.



Inspect the appliance before using it and check it for damage.



Never submerge or spray the appliance.



Do not press the buttons with a sharp object.



Protect the controls against dirt and grease.



During use some parts will become very hot.



Do not position the container on open fire or on a hotplate.



First disconnect the electric cable before transporting the container.



It is advisable to take the plug out of the socket and close the water tap if the appliance is not going to be used for longer periods of time.

Preparations

- Put the cables with inlet plug into the back of the container and insert the plug into the socket of the flow water heater (fig. 1-1).
- The inner pot of the container must always be fresh and clean.
- Place the coffee blender into the container. The blender guarantees a uniform quality of the coffee, which makes stirring the coffee (with loss of time, temperature and aroma) unnecessary. The temperature of the coffee is kept at a temperature of 80-85°C. The storage time of the coffee is determined by the blend of coffee and is usually 1 à 1,5 hours.

Basic rules for brewing coffee

- Use regular ground coffee ( $\pm 50$  gram/liter)
- Keep the inner pot, filter unit and the mixer clean.

Tip: always keep the basket filter paper in the original packing!

- This means the paper keeps its original (basket) shape.
- This prevents the paper from collapsing or not fitting in the filter.

- A Filter lid with water distributor
- B Basket filter paper
- C Basket filter
- D Blender
- E Insulated lid
- F Container

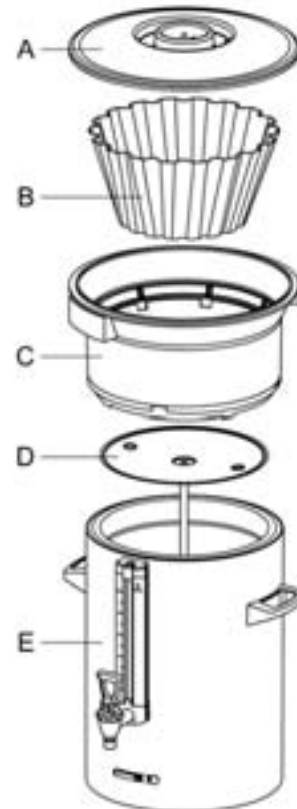

### 4.2.1 Brewing coffee

Switch on the appliance by putting the ON/OFF switch (⊕) in position I, the display lights up and you will hear a beeping sound (1x short). Then the display indicates the standard brewing amounts.

Select one of the four brewing amounts.



The selected brewing amount including a recommended coffee dosage appears in the display. Tip: If you do not want the selected brewing amount, you can increase/decrease it with the + or - button. The recommended coffee dosage changes accordingly.

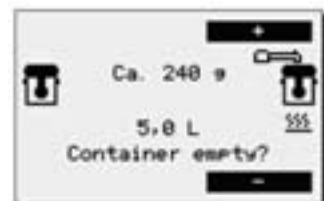

Place a basket filter paper in the basket filter and fill it with the recommended brewing amount of coffee (standard ground). Spread the coffee evenly in the filter and then put the filter lid on.

Place the filter unit on the container and position the swivel arm above the centre of the filter.

Press the START button (✓) to start the brewing process. In the display appears the text: Processing. The container heating switches on automatically, the heating should be switched off manually (☹) if the container is empty. During the coffee brewing process, the display shows the selected brewing amount (below) and the amount of water already gone through the filter (above).

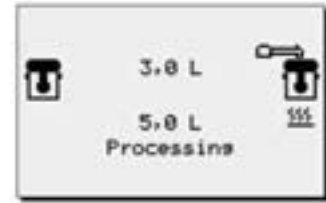

When the water supply stops coming out of the swivel arm you will hear a beeping sound (1x short). In the display appears the text: Leaking out. The leak out time is set as standard to approx. 5 minutes, and its ending is indicated by a beeping sound (3x short).



Remove the synthetic filter after it has been used and put the insulated lid on the container.

Clean the synthetic filter.

After the brewing process you can draw off a cup of coffee by using the no-drip tap on the container.



#### Tip

- If the swivel arm and/or the container are moved out of position before and/or during the brewing process, the brewing process will stop, a swivel arm and/or container symbol will appear in the display and you will hear a beeping signal (2x short). Once the positioning fault has been resolved the brewing process can be restored by pressing the START button (✓). See "Error reporting symbols".
- The brewing process can be interrupted at any moment with the STOP button (✗). The brewing process should then be considered as lost.
- Prepare another brewing process by getting the second synthetic filter ready if required. Once the water supply has stopped coming from the swivel arm, you can position the swivel arm above the other filter and start a new brewing process immediately. The dripping symbol from the 1st container will then disappear.

### 4.2.2 Brewing tea

For the preparation of tea you can follow the same steps as the ones described for the coffee brewing process. However, instead of using a coffee making unit, you should use a tea filter and disk (optional).

1. Put the tea, loose or in bags, in the tea filter approximately 6 grams per liter.
2. Insert the tea filter into the disk (B) already placed in the container.
3. Place the filling pipe (A) on the tea filter. Then position the swivel arm over the pipe.
4. Select the brewing quantity and start the brewing process.
5. Remove the pipe and the tea filter after the tea has been made. **ATTENTION: the filling pipe and filter are HOT!**
6. After brewing put the insulated lid on the container to avoid loss of temperature and taste.
7. Clean the tea filter immediately after use.

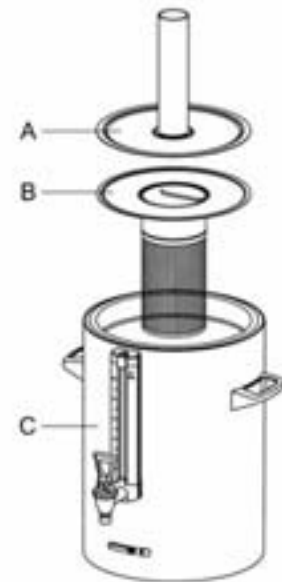

- A Filling pipe
- B Tea filter with disk
- C Container with lid



The optimum extraction time is minimally 4 minutes and maximally 15 minutes. After more than 15 minutes the flavor of the tea deteriorates.

### 4.2.3 Timer function

The appliance comes with a built-in timer clock as standard. You can use this to start a coffee brewing process at a certain time.

Press the timer button (🕒).

Set the required start time (day/hour/min) with the left and right selection buttons (fig. 9A) and confirm your setting with the START button (✔). The day automatically moves to the next day when the hour setting goes past 24:00. Confirm your choice with the START button (✔).



Select the required brewing quantity (fig. 9B) and confirm your choice with the START button.



The display shows.

Place a basket filter paper in the basket filter and fill it with the recommended brewing amount of coffee (standard ground) as shown in the display. Spread the coffee evenly in the filter and put the filter lid on. Then place the filter unit on the container, and position the swivel arm above the centre of the filter.

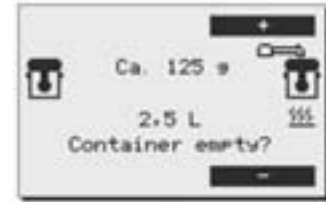

Check if the container is empty. Confirm your choice with the START button .

Explanation of the display:

- Clock symbol (flashing): timer clock is activated
- The brewing quantity, start time and day are displayed.
- Swivel arm/container symbol: The coffee maker is ready.
- The appliance may NOT be switched off!

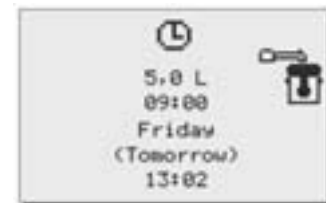





Tip

- The timer clock function can only be cancelled by pressing the STOP button .
- The container heating switches on automatically 5 minutes before the set time (pre-heating). The coffee brewing process is switched off during an activated timer clock function. The container heating can be used normally, for example, to keep the coffee on the left warm, while on the right the coffee brewing process is pre-programmed. The timer can be programmed a maximum of 6 days in advance. This enables you to bridge a long weekend easily.
- The swivel arm and container safety devices remain active. If the swivel arm moves out of position, for example, it is detected immediately and a warning symbol appears in the display followed by a beeping sound (2x short). Once the swivel arm is moved back to the correct position, the timer clock is active again.



### 4.2.4 The operator menu [5, 1x5, 10, 1x10, 20, 1x20, 2x5, 2x10, 2x20]

This chapter describes how the different settings can be changed by trained, qualified personnel. To gain access to the operator menu, read below. Once in the operator menu the control panel has the following functions:

- Button  selection arrow → up
- Button  selection arrow → down
- Button  back (without saving changes)
- Button  accept (activate)

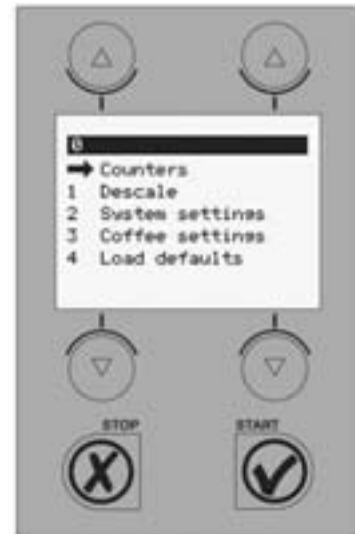



### 4.2.5 Menu functions

You have the possibility of changing settings and have access to a number of maintenance functions via the operator menu. It is possible to select the following functions:





| Menu | Explanation of Operator menu |
|------|------------------------------|
| 0    | Counters                     |
| 1    | Descaling                    |
| 2    | System settings              |
| 3    | Coffee settings              |
| 4    | Load defaults                |
| 5    | Load defaults [W]            |

#### Getting access to the operator menu

1. Switch the appliance off (0)
2. Hold the START button () and switch on (I) the ON / OFF switch ()
3. Release the START button when the display lights up. In the display appears: Operator menu. Press any button
4. Press any button. In the display appears: Enter PIN: \_ \_ \_ \_ \_
5. Look up the associated 5 digit PIN and enter it using the numbered buttons in the display (5.3 to 5.6). Please note: the code number is produced at random, so the PIN is always different!
6. After entering the PIN the Operator menu will light up in the display.

| Code no. | PIN       |
|----------|-----------|
| 1        | 4 2 1 2 2 |
| 2        | 3 3 4 4 3 |
| 3        | 1 4 1 1 3 |
| 4        | 2 4 2 1 2 |
| 5        | 3 3 3 1 3 |
| 6        | 1 4 4 4 1 |
| 7        | 4 1 2 3 1 |
| 8        | 3 4 3 1 4 |
| 9        | 4 2 1 3 4 |
| 10       | 3 3 3 1 4 |
| 11       | 4 2 3 2 2 |
| 12       | 4 3 2 2 2 |
| 13       | 3 2 2 4 4 |
| 14       | 3 3 1 2 4 |
| 15       | 3 4 3 1 2 |
| 16       | 3 4 4 2 4 |
| 17       | 1 4 2 2 4 |
| 18       | 1 3 2 4 4 |
| 19       | 3 3 4 4 1 |
| 20       | 1 4 1 3 4 |

Scrolling through the menu and activating the functions

- Move the arrow ➡ to the required menu item using the selection buttons  .
- You activate the required menu by using the START button .
- By pressing the STOP button  you go back to the previous screen without saving the changes made.

Confirm a change by pressing the START button . You will hear a short beeping sound.

Closing the operators menu:

1. Press the STOP button  until the user menu reappears.
2. Check if the changed settings are as required. If the settings are not as required, follow the procedure again.

While you are in the settings menu the appliance will not fill or heat up

### 4.2.6 Settings step by step

#### Counters (Menu 0) [5, 1x5, 10, 1x10, 20, 1x20, 2x5, 2x10, 2x20]

PIN ➡ Counters ➡ then select the counter item

An overview of all counter functions follows in the display. At the top of the display is a navigation bar on which the selected menu item number is shown.

| Menu | Explanation of Operator menu           |
|------|--|
| 0.0  | Daily counter of coffee made in litres |
| 0.1  | Reset daily counter of coffee made     |
| 0.2  | Total counter of coffee made in litres |

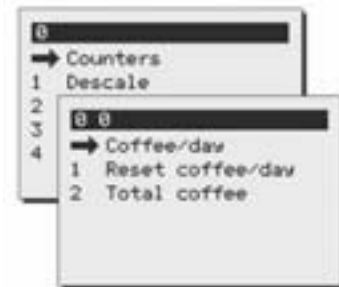

1. Select the required counter, and confirm with the START button .
2. Read the counter reading or reset the counter as required.

#### Descaling (Menu 1) [1x5, 1x10, 1x20, 2x5, 2x10, 2x20]

PIN ➡ Descaling ➡ then select function

An overview of all descaling functions follows in the display. At the top of the display is a navigation bar on which the selected menu function number is shown.

| Menu | Explanation of Operator menu |
|------|------------------------------|
| 1.0  | Flow counter                 |
| 1.1  | Start flow counter           |

Flow counter (Menu 1.0)



After activating the flow counter you can read how many litres away from a descaling signal the coffee maker is. Example: The diagram opposite indicates that the coffee making part (flow system) is still 961 litres away from a descaling signal. The counters are automatically reset after the relevant descaling program has been run.



Warnings

- Respect the descaling intervals indicated by the descale indicator symbol.
- Delaying maintenance of the heating system can lead to high repair costs and can invalidate the guarantee.
- When descaling, always pay attention to the directions on the scale remover.
- Keep up with the maintenance requirements for the appliance
- It is advisable to wear safety glasses and protective gloves when descaling.
- Wash your hands thoroughly after descaling.
- All repairs should be carried out by a trained, competent service engineer.
- The plug must always be pulled out of the power socket whenever the appliance has to be opened for repairs and other (cleaning) purposes.

Starting the coffee maker descaling program (Menu 1.1)

Preparation

- Move the swivel arm above an empty container and synthetic filter.
- Brew the smallest brewing amount (without coffee) once. The advantage of this is that the element is well preheated, so that descaling is better and takes less time.
- Carefully read the caution notice and the directions on the sachet Animo scale remover.
- Dissolve 2 sachets of 50 gram Animo scale remover into 2 litre of warm water (60°C). Stir the solution thoroughly so that the powder is completely dissolved.

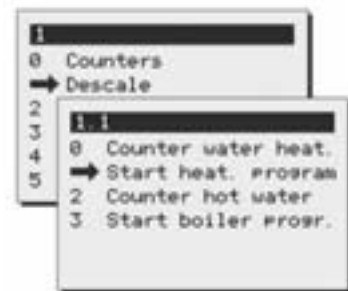

Remove the filter and place a plastic container under the outlet of the swivel arm to collect the scale remover.

- Follow the instructions shown on the display and confirm each action with .

Display: 1/5 Place measuring cup. Press start .



Stopping the program

The program can be cancelled at any time until the solution is poured in. Once the solution has been poured in, the program must always be completed. In case of an emergency stop, the STOP button can always be used. The program will then stop, but not be finished.

- Remove the cap from the descaling opening left of the swivel arm.
- Insert the descaling funnel (A) into the descaling opening. Push the funnel downward as far as possible.
- Slowly pour the scale remover into the funnel. The scale remover will enter the boiler element by the supply pipe and will come out of the swivel arm as foam.
- Repeat the procedure described above if there is a great amount of foam.
- Press the START button  to continue the program.



Display: 2/5 <- funnel left. Pour solution through. Ready? Press start .

The program is now ready to flush the system 3 times, so that the remaining scale remover can be removed from the heating system. Remove the funnel and replace the cap. Remove the plastic container with the collected scale remover and replace the filter.



Display: 2/5 Remove funnel. Place filter. Press Start .



Display: 3/5 Rinse. Press Start .



Press the START button  to start the 1st rins cycle.

Display: 3/5 Rinse. Please wait. The coffee maker will heat up. The container will be filled with 2 litres. There will be 3 beeping signals after the 1st rinsing cycle. Display: 3/5 Empty container. Press Start . Once the container is empty press the START button .



Display: 4/5 Rinse. Press Start ✓.

Press the START button ✓ to start the 2nd rinsing cycle.

Display: 4/5 Rinse. Please wait. The coffee maker will heat up. The container will be filled with 2 litres. There will be 2 beeping signals after the 2nd rinsing cycle. Display: 4/5 Empty container. Press Start ✓.

Once the container is empty press the START button ✓.



Display: 5/5 Rinse. Press Start ✓.

Press the START button ✓ to start the 3rd rinsing cycle.

Display: 5/5 Rinse. Please wait. The coffee maker will heat up. The container will be filled with 2 litres. There will be 3 beeping signals after the 3rd rinsing cycle.

Display: 5/5 Empty container. Press Start ✓.

Once the container is empty press the START button ✓.



The descaling program is now complete and the descaling menu will reappear in the display. The flow counter will automatically be reset to the starting value. Exit the menu by pressing the STOP button X twice, or select another menu function.

### Descaling (Menu 1) [5, 10, 20]

PIN ➡ Descaling ➡ then select function

An overview of all descaling functions follows in the display. At the top of the display is a navigation bar on which the selected menu function number is shown.

| Menu | Explanation of Operator menu |
|------|------------------------------|
| 1.0  | Flow counter                 |
| 1.1  | Start flow counter           |

Flow counter (Menu 1.0)

After activating the flow counter you can read how many litres away from a descaling signal the coffee maker is. Example: The diagram opposite indicates that the coffee making part (flow system) is still 961 litres away from a descaling signal. The counters are automatically reset after the relevant descaling program has been run.



Warnings

- Respect the descaling intervals indicated by the descale indicator symbol.
- Delaying maintenance of the heating system can lead to high repair costs and can invalidate the guarantee.
- When descaling, always pay attention to the directions on the scale remover.
- Keep up with the maintenance requirements for the appliance
- It is advisable to wear safety glasses and protective gloves when descaling.
- Wash your hands thoroughly after descaling.
- All repairs should be carried out by a trained, competent service engineer.
- The plug must always be pulled out of the power socket whenever the appliance has to be opened for repairs and other (cleaning) purposes.

Starting the coffee maker descaling program (Menu 1.1)

Preparation

- Move the swivel arm above an empty container and synthetic filter.
- Brew the smallest brewing amount (without coffee) once. The advantage of this is that the element is well preheated, so that descaling is better and takes less time.
- Carefully read the caution notice and the directions on the sachet Animo scale remover.
- Dissolve 2 sachets of 50 gram Animo scale remover into 2 litre of warm water (60°C). Stir the solution thoroughly so that the powder is completely dissolved.

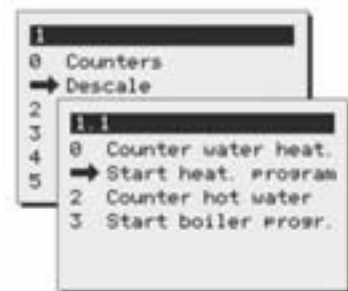

Remove the filter and place a plastic container under the outlet of the swivel arm to collect the scale remover.

- Follow the instructions shown on the display and confirm each action with

Display: 1/5 Place measuring cup. Press start .



Stopping the program

The program can be cancelled at any time until the solution is poured in. Once the solution has been poured in, the program must always be completed. In case of an emergency stop, the STOP button can always be used. The program will then stop, but not be finished.

- Remove the cap from the descaling opening left of the swivel arm.
- Insert the descaling funnel (A) into the descaling opening. Push the funnel downward as far as possible.
- Slowly pour the scale remover into the funnel. The scale remover will enter the boiler element by the supply pipe and will come out of the swivel arm as foam.
- Repeat the procedure described above if there is a great amount of foam.
- Press the START button  to continue the program.

2/5  
 ← funnel left  
 Pour solution through  
 Ready? Press START



Display: 2/5 ← funnel left. Pour solution through. Ready? Press start .

The program is now ready to flush the system 3 times, so that the remaining scale remover can be removed from the heating system. Remove the funnel and replace the cap. Remove the plastic container with the collected scale remover and replace the filter.

Display: 2/5 Remove funnel. Place filter. Press Start

2/5  
 Remove funnel  
 Place filter  
 Press Start

Display: 3/5 Rinse. Press Start .

3/5  
 Rinse  
 Press Start

Press the START button  to start the 1st rins cycle.

Display: 3/5 Rinse. Please wait. The coffee maker will heat up. The container will be filled with 2 litres. There will be 3 beeping signals after the 1st rinsing cycle. Display: 3/5 Empty container. Press Start . Once the container is empty press the START button .

3/5  
 Rinse  
 Please wait

3/5  
 Empty container  
 Press Start

**Operation instructions**

Display: 4/5 Rinse. Press Start ✓.



Press the START button ✓ to start the 2nd rinsing cycle.

Display: 4/5 Rinse. Please wait. The coffee maker will heat up. The container will be filled with 2 litres. There will be 2 beeping signals after the 2nd rinsing cycle. Display: 4/5 Empty container. Press Start ✓.



Once the container is empty press the START button ✓.

Display: 5/5 Rinse. Press Start ✓.



Press the START button ✓ to start the 3rd rinsing cycle.

Display: 5/5 Rinse. Please wait. The coffee maker will heat up. The container will be filled with 2 litres. There will be 3 beeping signals after the 3rd rinsing cycle.



Display: 5/5 Empty container. Press Start ✓.



Once the container is empty press the START button ✓.

The descaling program is now complete and the descaling menu will reappear in the display. The flow counter will automatically be reset to the starting value. Exit the menu by pressing the STOP button ✗ twice, or select another menu function.

**System settings (menu 2)**

PIN ➡ System settings ➡ then select function

An overview of all system settings follows in the display. At the top of the display is a navigation bar on which the selected menu function number is shown.

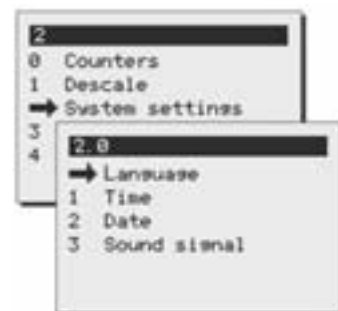

| Menu | Explanation of Operator menu |
|------|------------------------------|
| 2.0  | Language                     |
| 2.1  | Time                         |
| 2.2  | Date                         |
| 2.3  | Sound signal                 |



Language (Menu 2.0)

Before using the appliance you must first set the desired language. The default language setting is English. Select the required language, and confirm your changes with the START button . Tip!: If Menu 4-Load defaults is activated, the altered language choices will remain unchanged.



Time (Menu 2.1)

Before using the appliance you must first set the time. Use the left selection button to set the hour Use the right selection button to set the minutes. Confirm your changes with the START button .



Date (Menu 2.2)

Before using the appliance you must first set the date. Use the left selection button to set the day Use the right selection button to set the month. The year count changes automatically every 12 months. Confirm your changes with the START button .



Sound signal (Menu 2.3)

When in use the appliance makes different sound signals. You can switch the sound signals off if desired. Select the required choice and confirm your changes with the START button .



### Coffee settings (Menu 3)

PIN → Coffee settings → then select function

An overview of all coffee settings follows in the display. At the top of the display is a navigation bar on which the selected menu function number is shown.

| Menu | Explanation of Operator menu |
|------|------------------------------|
| 3.0  | Water volume                 |
| 3.1  | Unit                         |
| 3.2  | Cup volume                   |
| 3.3  | Mug volume                   |
| 3.4  | Button 1                     |
| 3.5  | Button 2                     |
| 3.6  | Button 3                     |
| 3.7  | Button 4                     |
| 3.8  | Auto container heating       |
| 3.9  | Descal indicator             |
| 3.10 | Coffee dosage                |
| 3.11 | Interval                     |
| 3.12 | 1st charge volume            |
| 3.13 | Leak out time                |

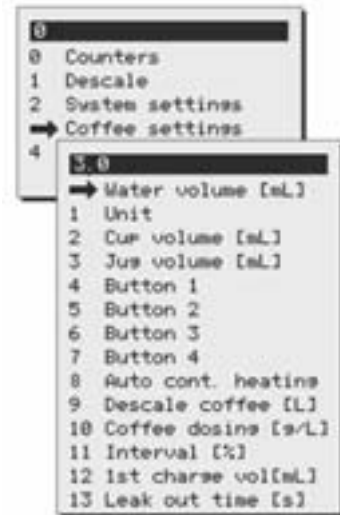

#### Water volume (Menu 3.0)



The container will overflow if too large an amount is set. The manufacturer accepts no responsibility for the consequences of changed settings.

During use, it can occur that the quantity of water in the container is not as required. This depends on the amount of coffee and the size of coffee ground used. The amount of water that comes out of the swivel arm is set to 6% - 10% extra water as standard. The table below shows the settings scope.



| Water volume |                  |                  |
|--------------|------------------|------------------|
| Model        | Factory settings | Settings         |
| CB 5W        | 5,300 ml         | 4,800-5,800 ml   |
| CB 10W       | 10,800 ml        | 9,800-11,800 ml  |
| CB 20W       | 22,000 ml        | 20,000-24,000 ml |



Increase or decrease the water volume [ml] with the selection buttons above and below the display. Confirm the changes made with START button or go back without making any changes by pressing the STOP button .

## Operation instructions

---

### Unit (Menu 3.1)

You can change the unit in which the selection buttons are shown in the display with this function. The unit can be set as Litres (standard), Jug or Cup.



Select the required unit and confirm your changes with the START  button or go back without saving any changes using the STOP button .

Please note: The counter menu continues to be displayed in litres.



### Cup volume (Menu 3.2)



You can change the volume of the cup with this function. The cup volume is set to 125 ml as standard. The settings scope is between 100 and 500 ml (1 ml steps).

Set the required cup volume and confirm your changes with the START button  or go back without saving any changes by pressing the STOP button .



### Jug volume (Menu 3.3)

You can change the volume of the jug with this function. The jug volume is set to 250 ml as standard. The settings scope is between 200 and 2500 ml (1 ml steps).

Set the required jug volume and confirm your changes with the START button  or go back without saving any changes by pressing the STOP button .





Changing the selection buttons (Menu 3.4 to 3.7)

You can set each selection button as required with this function. The four selection buttons are set in the factory as shown in the table below .

With the help of Buttons 1 to 4 (menu 3.4 to 3.7), the choice can be set within the scope with associated step size indicated in the table below.

| Selection buttons unit litres |                  |                |       |
|-------------------------------|------------------|----------------|-------|
| Model                         | Factory settings | Settings scope | Step  |
| CB 5W                         | 1-3-4-5 l        | 1-5 l          | 0,5 l |
| CB 10W                        | 2,5-5-7,5-10 l   | 2-10 l         | 0,5 l |
| CB 20W                        | 5-10-20-40 l     | 4-20 l         | 1 l   |

Set the required amount for button 1 and confirm your changes with the START button  or go back without saving any changes by pressing the STOP button . Repeat this for buttons 2 to 4.

Have you changed the unit of Litres to Cup or Jug? The litre setting is automatically calculated by the relevant litre setting divided by the cup or jug volume. The four selection buttons then automatically have the settings as shown in the following overview (Table 3 + 4) Each selection button within the settings scope and associated step size can be set with the help of the menu buttons 3.4 to 3.7.

| Selection buttons unit cups |                  |                |        |
|-----------------------------|------------------|----------------|--------|
| Model                       | Factory settings | Settings scope | Step   |
| CB 5W                       | 8-24-32-40       | 8- 4 cups      | 1 cup  |
| CB 10W                      | 20-40-60-80      | 20-80 cups     | 1 cup  |
| CB 20W                      | 40-80-120-160    | 8- 4 cups      | 5 cups |

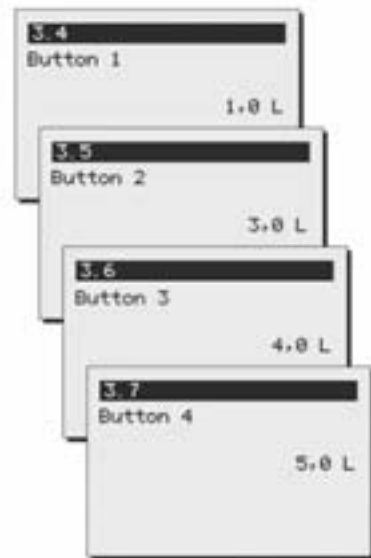

| Selection buttons unit jugs |                  |                |       |
|-----------------------------|------------------|----------------|-------|
| Model                       | Factory settings | Settings scope | Step  |
| CB 5W                       | 4-12-16-20       | 4-20 jugs      | 1 jug |
| CB 10W                      | 10-20-30-10      | 10-40 jugs     | 1 jug |
| CB 20W                      | 20-40-60-80      | 20-80 jugs     | 1 jug |



## Operation instructions

Switching on the container heating automatically (menu 3.8)

When starting a coffee making process the appliance automatically switches the right container heating on. The container heater then stays switched on and must always be switched off manually. You can switch this function off if required.

Set the required choice and confirm your changes with the START button  or go back without saving any changes by pressing the STOP button .



Coffee making descale indicator settings (menu 3.9)

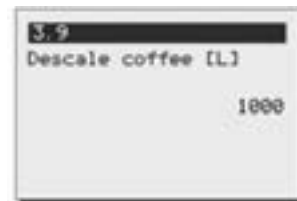

Before you start using the appliance you must first set the descale indicator.

- The default descale indicator is set to 1000 litres (average water hardness) and has a scope of 0 to 9999 litres in steps of 100
- Use the table 5 below and select the relevant water hardness in the left column (°D). On the right you can read after how many litres (recommended) the system must be descaled.
- Once the set amount of litres has been reached a spanner symbol will appear in the display. The appliance will continue to work normally so that descaling can be done at a more suitable time.
- In the Descaling menu 1.0 you can see how many litres away from a descale indicator signal the system still is.



| Water quality | Hardness |       |         |           | Descal indicator litres |
|---------------|----------|-------|---------|-----------|-------------------------|
|               | °D       | °F    | mmol/l  | mgCaCo3/l |                         |
| Very hard     | 18-30    | 32-55 | 3,2-5,3 | 321-536   | 250                     |
| Hard          | 12-18    | 22-32 | 2,2-3,2 | 214-321   | 500                     |
| Average       | 8-12     | 15-22 | 1,4-2,2 | 268-214   | 1000*                   |
| Soft          | 4-8      | 7-15  | 0,7-1,4 | 72-268    | 1500                    |
| Very soft     | 0-4      | 0-7   | 0-0,7   | 0-72      | 2000                    |

\*Standard setting



Set the required number of litres and confirm your changes with the START button  or go back without saving any changes by pressing the STOP button .

- Contact your local water company if you are unsure about the hardness of your tap-water.

### Coffee dosage (menu 3.10)

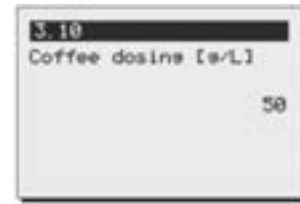
When an amount is selected, the recommended amount of ground coffee (grams) that should be put in the filter unit in order to make the selected amount of coffee appears in the display. The amount of coffee is set to 50 grams/litre as standard and can be set from 0 to 100 grams in steps of 1 gram.



Set coffee dosage and confirm your changes with the START button  or go back without saving any changes by pressing the STOP button .



If the coffee dosage advice is not desired you can switch it off by setting the grams/litre value to 0.

Please note: When setting larger amounts of coffee a negative correction factor is applied to the calculation. This means that the coffee dosage advice is lower than the result of the calculation 'brewing quantity x coffee dosage'.

### Interval (menu 3.11)

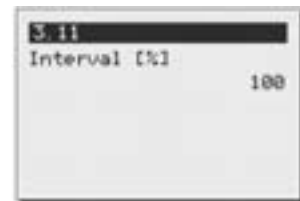

Using very finely ground coffee or very soft water will result in the water running through the coffee filter more slowly. Pausing the hot water pouring after the 1st charge volume (half way through the making process) for periodic intervals (that can be set) can prevent the coffee filter from overflowing.



#### Interval Settings

- The interval is set to 100% as standard. The brewing process can then run smoothly.
- The interval can be set from 100% to 50% in steps of 5%. After a setting has been made the controller calculates the time out interval itself (see table below).
- If the hot water pouring switches to the interval mode after the 1st charge, the water supply and pausing will continue until the required volume has been reached.
- The interval setting and the 1st charge volume can only be determined by trial and error by keeping an eye on the filtering process during the coffee making.

## Operation instructions

Set the required number of litres and confirm your changes with the START button  or go back without saving any changes by pressing the STOP button .



| Interval | Water pouring time | Interval-time |
|----------|--------------------|---------------|
| 100%     | Continue           | 0 sec         |
| 95%      | 45 sec             | 4,5 sec       |
| 90%      | 45 sec             | 9 sec         |
| 85%      | 45 sec             | 13,5 sec      |
| 80%      | 45 sec             | 18 sec        |
| 75%      | 45 sec             | 22,5 sec      |
| 70%      | 45 sec             | 27 sec        |
| 65%      | 45 sec             | 31,5 sec      |
| 60%      | 45 sec             | 36 sec        |
| 55%      | 45 sec             | 40,5 sec      |
| 50%      | 45 sec             | 45 sec        |

### 1st charge menu (menu 3.12)

The 1st charge volume can be increased if it is only found outlater in practise that the filtering process threatens to overflow

### Setting the 1st charge volume

- The 1st charge volume only becomes active if the interval is set at 95% or less.
- The 1st charge volume is set for half way through the brewing process as standard.
- The 1st charge volume can be set according to the table below.

Set the desired 1st charge volume and confirm your changes with the START button  or go back without saving any changes by pressing the STOP button .

| Model  | Factory settings | Settings scope | Step |
|--------|------------------|----------------|------|
| CB 5W  | 2.500 ml         | 2500-4500 ml   | 250  |
| CB 10W | 5.000 ml         | 5000-9000 ml   | 250  |
| CB 20W | 10.000 ml        | 8000-18000 ml  | 250  |



Leak out time (menu 3.13)

The leak out time starts once the hot water distribution is stopped. The leak out time through the filter can vary depending on the type, size and/or amount of coffee.

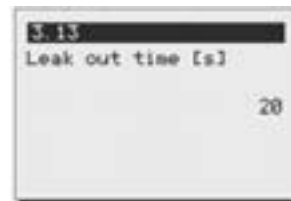

Leak out time settings

- If no leak out time is required the time can be set to 0. There will then be no dripping symbol in the display followed by a sound signal..

Set the required leak out time and confirm your changes with the START button or go back without saving any changes by pressing the STOP button .

| Model  | Factory settings | Settings scope | Step |
|--------|------------------|----------------|------|
| CB 5W  | 240 sec          | 0-900          | 10   |
| CB 10W | 300 sec          | 0-900          | 10   |
| CB 20W | 360 sec          | 0-900          | 10   |

**Load defaults (menu 4) [5, 1x5, 10, 1x10, 20, 1x20, 2x5, 2x10, 2x20]**

You can restore all the default settings except for the language setting with this function. Please note: All settings that you have changed in the operator menu will be lost.

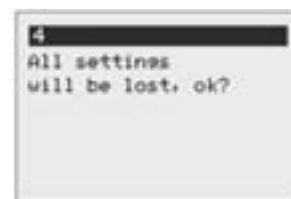

Press the START button to load the default settings or go back without making any changes by pressing the STOP button .



## 4.3 After use

### 4.3.1 Cleaning



Do not leave the appliance unattended when maintenance is being performed



Never submerge or spray the appliance



The plug must be taken out of the socket if the appliance has to be opened for cleaning or repairs



Always follow the manufacturer instructions when using the scale remover.



When descaling the appliance, it is advisable to wear safety glasses and protective gloves.

#### Cleaning general

- The outside of the container can be cleaned with a wet cloth, then wiped dry. Never use any abrasives, as these can cause scratches and dull spots.
- Always take the connection lead out of the multiple socket during cleaning and maintenance activities and close it with the splash protector (B). An opened splash protector (A) protects the socket connection from moisture running in from above. A closed splash protector protects the multiple socket from dirt and moisture.
- Attention! Do not place the container type CNe (electrical execution) in the dish washer or sink.
- The container type CNi (insulated execution) is allowed to be cleaned in the dish washer or sink, because of its IP 65 construction.
- Do not leave the filter and the blender on a container which is not in use. Place the lid oblique on the container, otherwise a stale taste may be the result.
- Always leave some clean water (2 cups) in the container, This stops the washers from drying out.

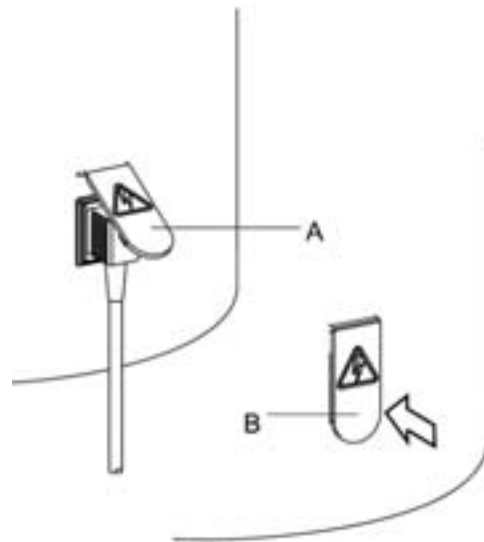

### Cleaning daily

- Rinse the inner pot of the container after use with hot water, or use if necessary Animo coffee fur remover. Empty the container with the no-drip tap.
- The filter, water distributor lid, blender and drip tray can be washed normally and rinsed clean. The filter and water distributor lid are allowed to be cleaned in the dishwasher.
- Despite daily cleaning coffee deposits can still remain in the inner pot and the gauge glass, see chapter “Cleaning weekly”, “Cleaning the tap” and “Cleaning the gauge glass”.

### Cleaning weekly

A sachet of coffee fur remover is supplied with the machine. Use is extremely simple.

Removal of coffee deposits from the inner pot:

1. Fill half of the container with warm water and dissolve a sachet of coffee fur remover in it.
2. Let the solution work for 15 to 30 minutes, then empty the container.
3. Rinse the container thoroughly with hot water a few times.

Removal of coffee deposits from the other parts:

1. Take a bowl filled with abt. 5 liter warm water and dissolve the coffee fur remover solvent from the sachet in it.
2. Put the parts that need to be cleaned in the bowl and soak them for 15 to 30 minutes.
3. Rinse several times with warm water. Repeat treatment if the result is insufficient.
4. Scatter coffee fur remover on very filthy spots and clean with a wet brush.

### Cleaning the tap

1. Unscrew the top of the tap by turning it to the left.
2. Pull the silicon sealer vertically away from the screw top
3. Put the parts to be cleaned in this solution and let it work for 15 to 30 minutes.
4. Then rinse off several times with warm water and put back together in reverse order, repeat if the results are insufficient.



### Cleaning the gauge glass



Risk of burning! Empty the container before you remove the gauge glass for cleaning.

Always treat the gauge glass with the necessary caution. Take the glass out of the protector with the help of a dry cloth and hold the gauge glass firmly with the cloth as you clean it with the gauge glass brush.

1. Empty the container, remove the filter and the coffee blender.
2. Take the gauge glass lid (A) off by pulling it vertically up from the protector profile.
3. Take a dry cloth, and use it to take the top of the gauge glass (C) from the recess and pull the gauge glass carefully diagonally up out of and loose from the tap connection.
4. Remove the bottom tulle (F) from the gauge glass and clean the gauge glass with the help of the supplied gauge glass brush. (careful fragile!)
5. Moisten the gauge glass ends + tulle and put the tulle back in the glass and push the gauge glass into the tap connection with the tulle (G).
6. Always put the gauge glass lid (A) vertically on the protector profile, push the top tulle with the index finger (in the middle of the gauge glass lid). Please note: make sure that the gauge glass lid stays firmly pushed against the container wall when placing it. Only then the gauge glass will stay well. (The lip in the gauge glass lid (A) must be behind the holding plate (B).

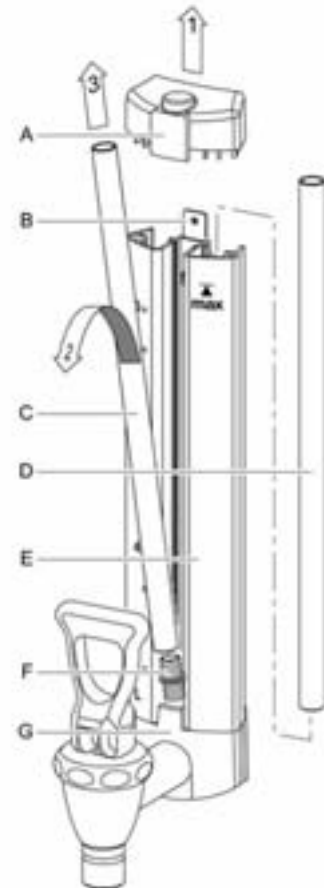

- A - Gauge glass lid
- B - Holding plate
- C - Gauge glass
- D - Extra gauge glass
- E - Protector profile
- F - Lower tulle
- G - Tap cap



On the inside of the gauge glass protector is a spare gauge glass (D). The assembly of the gauge glass system is much easier if you moisten the gauge glass ends and tulle well.

### 4.3.2 Periodic descaling activities

This chapter describes the periodic descaling activities of the machine that can only be executed by trained, qualified personnel.



Observe the descaling intervals indicated by the descaling indicator symbol.



Overdue maintenance to the heating system can result in high repair costs and annulment of the guarantee.



Always follow the manufacturer instructions when using the scale remover.



Do not leave the appliance unattended when maintenance is being performed.



When descaling the appliance, it is advisable to wear safety glasses and protective gloves.



Wash your hands after descaling.

### **Descaling the coffee maker**

After entering the Operator PIN you have access to the descaling menu where you can start the descaling program for the coffee maker. Follow the descaling procedure as described in the operator menu.

## **5. Installation**

### **5.1 General**

This appliance may only be positioned and connected by a qualified service engineer. The following rules must be observed:

- only suitable for indoor use
- not suitable for use in humid areas
- not suitable for areas with explosion hazard

## 5.2 Unpacking [1x5, 1x10, 1x20, 2x5, 2x10, 2x20]

The machine has been carefully packed to prevent damage being caused to your new appliance.

Remove the packing carefully without using sharp objects. Check if the appliance is complete.

The appliance (tower) will be delivered already mounted on a base plate according to the specifications below.



| Model                                   | CB 2x_ | CB 1x_L | CB 1x_R |
|---|--------|---------|---------|
| - 1 swivel arm                          | 1      | 1       | 1       |
| - 1 drip tray with grid                 | 1      | 1       | 1       |
| Carton with basket filter               | 2      | 1       | 1       |
| - 1 sythetic filter                     |        |         |         |
| - 1 water distributor lid               |        |         |         |
| - 1 set basket filter paper abt. 25 pcs |        |         |         |
| Carton with container                   | 2      | 1       | 1       |
| - 1 container                           |        |         |         |
| - 1 insulated lid                       |        |         |         |
| - 1 blender/transport disk              |        |         |         |
| - 1 gague glass brush                   |        |         |         |
| - 1 sticker sheet coffee/tea            |        |         |         |
| - 1 electric cable 1,5m                 |        |         |         |
| Carton with accessories column/base     | 1      | 1       | 1       |
| - 1 connection hose 1,5m                |        |         |         |
| - 1 descaling funnel                    |        |         |         |
| - 1 sachet coffee fur remover           |        |         |         |
| - 1 sachet scale remover                |        |         |         |
| - 1 manual                              |        |         |         |
| - 1 set centric shoulders (4x)          |        |         |         |
| - 2 electric cables 0,6m                |        |         |         |

Please contact your dealer in case parts are missing or damaged.



Water always remains in the heating system: for this reason the appliance must not be placed in an area where the temperature can fall below freezing point.

### 5.3 Unpacking [5, 10, 20]

The machine has been carefully packed to prevent damage being caused to your new appliance. Remove the packing carefully without using sharp objects. Check if the appliance is complete. The appliance (column) will be delivered already mounted on a console according to specifications below.



| Model                           | CB 5 / 10 / 20 |
|---------------------------------|----------------|
| Carton with accessories column: | 1              |
| - wall bracket                  | 1              |
| - drip tray with grid           |                |
| - connection hose 1,5m          | 1              |
| - descaling funnel              | 1              |
| - sachet coffee fur remover     | 1              |
| - swivel arm                    | 1              |
| - manual                        | 1              |

Please contact your dealer in case parts are missing or damaged.



Water always remains in the heating system: for this reason the appliance must not be placed in an area where the temperature can fall below freezing point.

### 5.4 Preparation for positioning

- Place the appliance at buffet height on a firm, level base that can withstand the weight of the machine when filled.
- Make sure that the appliance is level and placed somewhere where it will not cause damage should leakage occur.
- Place the appliance in such a way that the descaler filling opening on the top of the column can be reached.
- The water supply line (G3/4" 15 mm pipe), a discharge for the overflow connection (25 mm hose) and the power connection must be within half a meter of where the machine is positioned.
- The user is responsible for ensuring that these technical installation preparations are executed according to local regulations by qualified engineers.
- The service engineer is only permitted to connect the appliance to the prepared connection points.

## 5.5 Water connection

Connect the appliance using the water hose to an easily accessible aeration tap that can be closed quickly if problems arise. The minimum water pressure may not be under 0,2 Bar (at 5L/min. flow pressure)



The appliance can only be connected to a cold water outlet.

### 5.5.1 Water treatment

You are emphatically advised to use a water softener and/or a water filter if the water contains too much chlorine or is too hard ( $>8^{\circ}\text{dH}$ ). This enhances the quality of the drink and precludes having to descale the appliance too often.

## 5.6 Water drainage

The appliance doesn't need to be drained.



## 5.7 Electrical connection



Supply voltages and frequencies can differ between countries. Check if the appliance is suitable for connection to the local power mains. Check if the details on the type plate correspond.

The earthed wall socket and the fused group with a main switch belong to the electrical installation. No heavy machines that could cause variations in power when being switched on, can be connected to this group. A machine with power current (three phase) is delivered from the factory without plug. At delivery, the machine must be provided with an electrically suitable plug as advised and provided by the installer.

The following points should be observed when wiring a new plug:

1. The green/yellow-coloured wire ("EARTH") should be connected to the terminal which is either marked with the letter "E", the "earth" symbol () , or coloured green or green/yellow.
2. The blue-coloured wire ("NEUTRAL") should be connected to the terminal which is either marked with the letter "N" or coloured black.
3. The brown-coloured wire ("PHASE") should be connected to the terminal which is either marked with the letter "L1, L2 and L3" or coloured red.

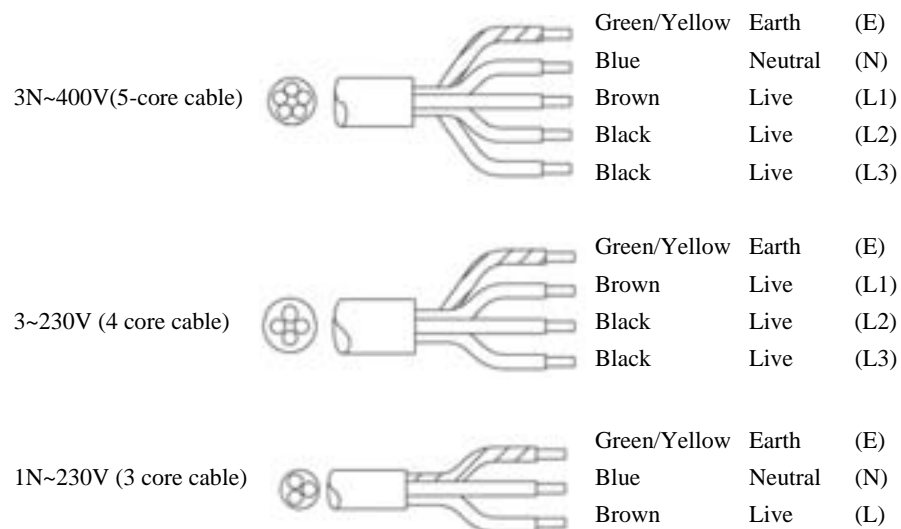

## 5.8 Connection on a counter [1x5, 1x10, 1x20, 2x5, 2x10, 2x20]

1. Connect the machine at counter level and on a solid flat surface.
2. Before the connections are made, check whether the main voltage corresponds to the voltage indicated on the type plate.
3. Determine the position of the machine on the counter.
4. If necessary, make the transits on the counter for electricity, water and drainage, see installation drawing for measurements.
5. Mount the supplied centering shoulders on the base plate.
6. Connect the electricity supply, cold water supply and the overflow.
7. Place the drip tray in front of the machine.
8. Place the containers against the centering shoulders, place the coffee blenders into the containers and put the filter units on the containers.
9. Connect the container(s) by using the supplied short (60 cm) connection cable and put the mains plug from the relevant column in the mains socket.
10. Position the swivel arm over the centre of the filter.

## 5.9 Mounting on a wall [5, 10, 20]

Mount the appliance on the wall with the aid of the bracket supplied in accordance with the condition of the mounting wall and with the aid of suitable plugs. In case of cellular concrete, plasterboard or similar walls of other materials screw right through them or apply extra wall reinforcement.

1. The local voltage should correspond to the specifications indicated on the type plate.
2. Determine the complete arrangement of the serving trolley(s) with flow water heaters.
3. Determine position of the flow water heater, see the figure below.
4. Mount the flow water heater to the wall with the aid of the bracket supplied and connect electricity, water supply and overflow pipe.
5. Position the serving trolley, container and filter next to the flow water heater (take the parking rails into account see point 6), adjust the stop of the swivel arm in such a way that the outlet is always above the centre of the filter. The stop can be reached by pulling the swivel arm up vertically.
6. Take note! the swivel arm should always be at a slight downward angle.
7. Determine the place of the parking rails and mount them on the wall at the correct height in such a way that the serving trolley will stand with its round push rubbers in between the parking rails.

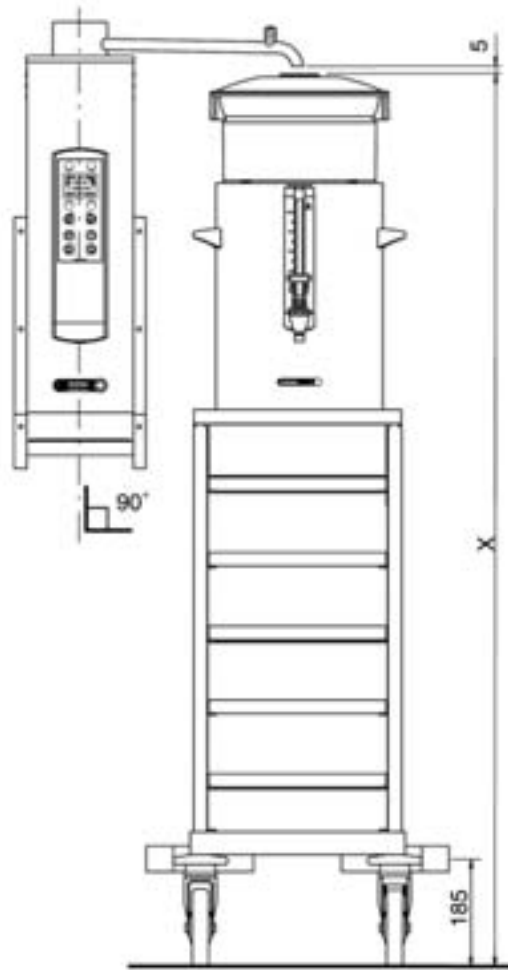

If only one serving trolley is placed next to the flow water heater, we recommend you to adapt the swivel arm protection (located under the swivel arm) on the side on which no serving trolley is placed. This prevents the possibility of starting the flow water heater when the swivel arm is in the opposite direction to the one where the serving trolley is placed. The adaptation is done as follows.

1. Remove the swivel arm by lifting it vertically out of the flow water heater.
2. Detach the relevant stop from the swivel arm bottom.
3. Remove the magnet from the underside of this stop.
4. Reassemble the stop on the bottom.
5. Place the swivel arm back on the flow water heater.
6. Test whether the flow water heater can only be activated when it is above the filter.

## 6. Troubleshooting



Have all repairs to the electrical system performed by a qualified service technician.

| PROBLEM        | Possible cause   | Measures  |
|----------------|--|---|
| C2 (coffee)    | Coffee maker doesn't work. Dry-boil protection switched off.   | Reset dry-boil protection coffee making unit. Check to see if the coffee maker needs to be descaled, and descale if necessary.                            |
| C3 (coffee) I  | Coffee maker doesn't fill any more   | Check the water pressure, turn the water supply taps completely open, check if the connecting hose is fastened. Problem solved, error message disappears. |
| C3 (coffee) II | Coffee maker fills too slowly.   | Check the water pressure, turn the water supply taps completely open, check if the connecting hose is fastened.   |
| C4 (coffee)    | Water inlet valve doesn't close properly.  | Call the service engineer or dealer.  |
| C7 (coffee)    | Minimum electrode fault.   | Call the service engineer or dealer.  |
| C8 (coffee)    | Error C3 changes to C8 after 10 minutes. The inlet valve is closed for safety. Please note: this also happens when the max level is reached! | Restore water supply and restart the coffee making process.   |
| C9 (coffee)    | Problems with registering the volume of water.   | Call the service engineer or dealer.  |

If your appliance is not functioning correctly, use this troubleshooting guide to see whether you can resolve the problem yourself. If not, please contact your dealer.

## 7. Technical specifications

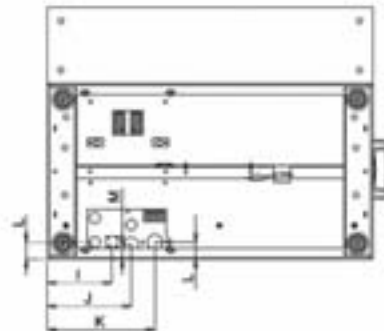
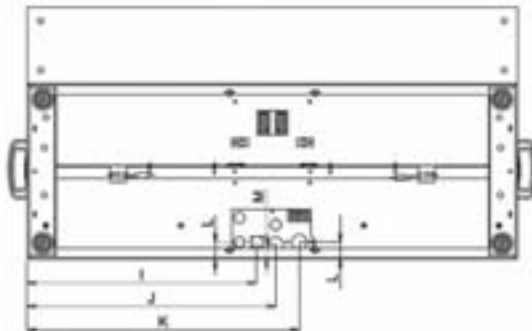
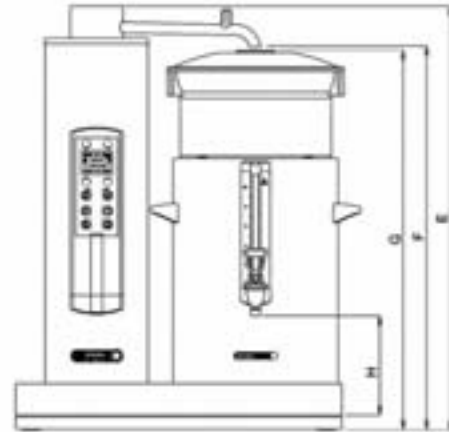
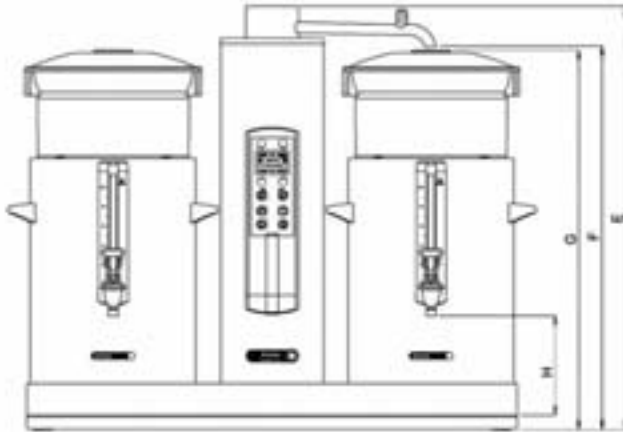
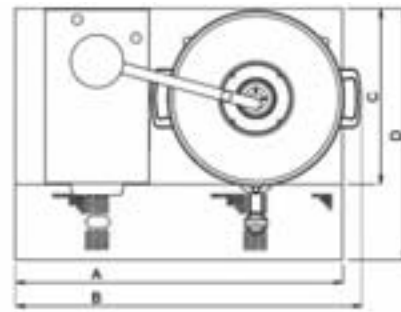
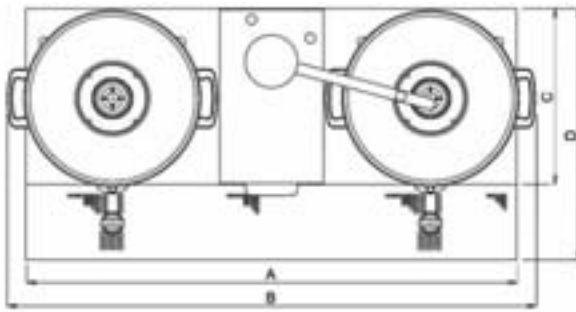

|     | CB 1x5 L | CB 1x10 L | CB 1x20 L | CB 1x5 R | CB 1x10 R | CB 1x20 R | CB 2x5 | CB 2x10 | CB 2x20 |
|-----|----------|-----------|-----------|----------|-----------|-----------|--------|---------|---------|
| A = | 530      | 599       | 653       | 530      | 599       | 653       | 770    | 907     | 1015    |
| B = | 554      | 634       | 693       | 554      | 634       | 693       | 818    | 977     | 1095    |
| C = | 325      | 325       | 360       | 325      | 325       | 360       | 325    | 325     | 360     |
| D = | 465      | 465       | 500       | 465      | 465       | 500       | 465    | 465     | 500     |
| E = | 692      | 784       | 886       | 692      | 784       | 886       | 692    | 784     | 886     |
| F = | 616      | 707       | 808       | 616      | 707       | 808       | 616    | 707     | 808     |
| G = | 611      | 702       | 803       | 611      | 702       | 803       | 611    | 702     | 803     |
| H = | 185      | 185       | 185       | 185      | 185       | 185       | 185    | 185     | 185     |
| I = | 356      | 425       | 479       | 116      | 116       | 116       | 356    | 425     | 479     |
| J = | 391      | 459       | 513       | 151      | 151       | 151       | 391    | 459     | 513     |
| K = | 435      | 504       | 558       | 195      | 195       | 195       | 435    | 504     | 558     |
| L = | 32       | 32        | 67        | 32       | 32        | 67        | 32     | 32      | 67      |
| M = | 27       | 27        | 62        | 27       | 27        | 62        | 27     | 27      | 62      |

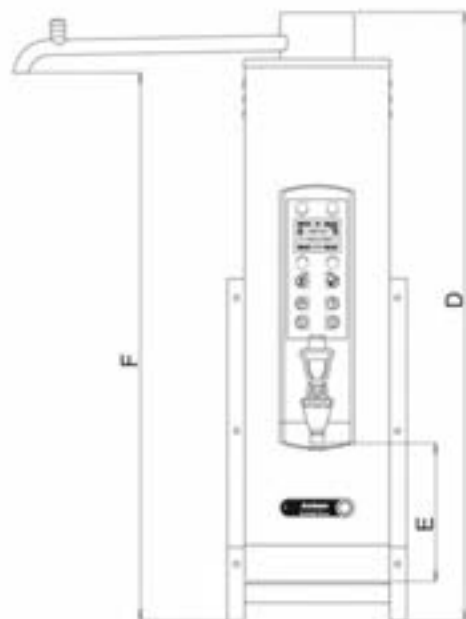
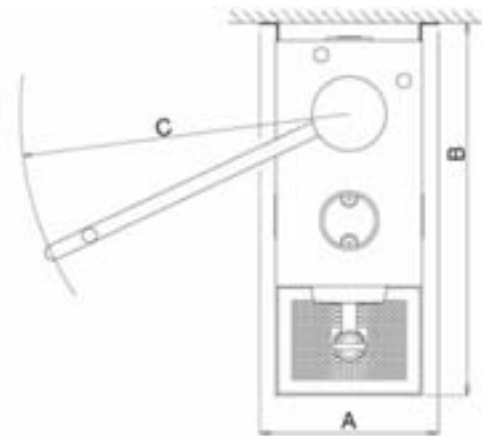

| Afmetingen / Dimensions / Maße ComBi-line |       |        |        |
|---|-------|--------|--------|
|   | CB 5W | CB 10W | CB 20W |
| A =                                       | 235   | 235    | 235    |
| B =                                       | 490   | 490    | 490    |
| C =                                       | 430   | 430    | 430    |
| D =                                       | 707   | 800    | 901    |
| E =                                       | 175   | 175    | 277    |
| F =                                       | 631   | 723    | 825    |
| G =                                       | 146   | 146    | 146    |
| H =                                       | 102   | 102    | 102    |
| I =                                       | 67    | 67     | 67     |
| J =                                       | 54    | 54     | 54     |
| K =                                       | 49    | 49     | 49     |

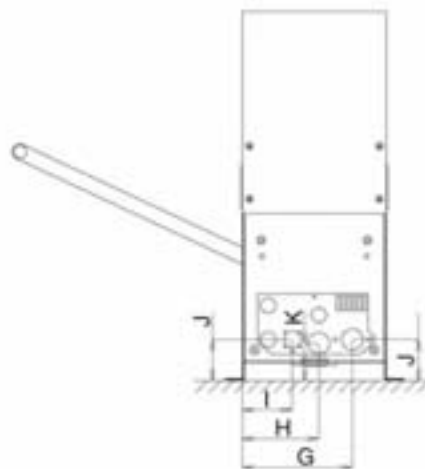

## Technical specifications

| Item                    | Model | Type  | Accessory | Voltage | Specification |
|-------------------------|-------|-------|-----------|---------|---------------|
| Measures                | CB    | 5     |           |         | 235x435x707   |
| Measures                | CB    | 10    |           |         | 235x345x799   |
| Measures                | CB    | 20    |           |         | 235x345x901   |
| Measures                | CB    | 1x5R  |           |         | 530x465x695   |
| Measures                | CB    | 1x10R |           |         | 599x465x785   |
| Measures                | CB    | 1x20R |           |         | 653x500x890   |
| Measures                | CB    | 1x5L  |           |         | 530x465x695   |
| Measures                | CB    | 1x10L |           |         | 599x465x785   |
| Measures                | CB    | 1x20L |           |         | 653x500x890   |
| Measures                | CB    | 2x5   |           |         | 770x465x695   |
| Measures                | CB    | 2x10  |           |         | 907x465x785   |
| Measures                | CB    | 2x20  |           |         | 1015x500x890  |
| Container volume litres | CB    | 5     |           |         | 5             |
| Container volume litres | CB    | 10    |           |         | 10            |
| Container volume litres | CB    | 20    |           |         | 20            |
| Container volume litres | CB    | 1x5R  |           |         | 5             |
| Container volume litres | CB    | 1x10R |           |         | 10            |
| Container volume litres | CB    | 1x20R |           |         | 20            |
| Container volume litres | CB    | 1x5L  |           |         | 5             |
| Container volume litres | CB    | 1x10L |           |         | 10            |
| Container volume litres | CB    | 1x20L |           |         | 20            |
| Container volume litres | CB    | 2x5   |           |         | 5             |
| Container volume litres | CB    | 2x10  |           |         | 10            |
| Container volume litres | CB    | 2x20  |           |         | 20            |
| Capacity l/h            | CB    | 5     |           |         | 30            |
| Capacity l/h            | CB    | 10    |           |         | 60            |
| Capacity l/h            | CB    | 20    |           |         | 90            |
| Capacity l/h            | CB    | 1x5R  |           |         | 30            |
| Capacity l/h            | CB    | 1x10R |           |         | 60            |
| Capacity l/h            | CB    | 1x20R |           |         | 90            |
| Capacity l/h            | CB    | 1x5L  |           |         | 30            |
| Capacity l/h            | CB    | 1x10L |           |         | 60            |
| Capacity l/h            | CB    | 1x20L |           |         | 90            |
| Capacity l/h            | CB    | 2x5   |           |         | 30            |
| Capacity l/h            | CB    | 2x10  |           |         | 60            |
| Capacity l/h            | CB    | 2x20  |           |         | 90            |
| Capacity cups/h         | CB    | 5     |           |         | 240           |
| Capacity cups/h         | CB    | 10    |           |         | 480           |
| Capacity cups/h         | CB    | 20    |           |         | 720           |
| Capacity cups/h         | CB    | 1x5R  |           |         | 240           |
| Capacity cups/h         | CB    | 1x10R |           |         | 480           |
| Capacity cups/h         | CB    | 1x20R |           |         | 720           |
| Capacity cups/h         | CB    | 1x5L  |           |         | 240           |



## Technical specifications

| Item                | Model | Type  | Accessory | Voltage | Specification      |
|---------------------|-------|-------|-----------|---------|--------------------|
| Capacity cups/h     | CB    | 1x10L |           |         | 480                |
| Capacity cups/h     | CB    | 1x20L |           |         | 720                |
| Capacity cups/h     | CB    | 2x5   |           |         | 240                |
| Capacity cups/h     | CB    | 2x10  |           |         | 480                |
| Capacity cups/h     | CB    | 2x20  |           |         | 720                |
| Electric connection | CB    | 5     |           |         | 230V 1~3,2 kW 16A  |
| Electric connection | CB    | 10    |           |         | 400V 3N~6,2 kW 10A |
| Electric connection | CB    | 20    |           |         | 400V 3N~9,2 kW 16A |
| Electric connection | CB    | 1x5R  |           |         | 230V 1~3,2 kW 16A  |
| Electric connection | CB    | 1x10R |           |         | 400V 3N~6,2 kW 10A |
| Electric connection | CB    | 1x20R |           |         | 400V 3N~9,2 kW 16A |
| Electric connection | CB    | 1x5L  |           |         | 230V 1~3,2 kW 16A  |
| Electric connection | CB    | 1x10L |           |         | 400V 3N~6,2 kW 10A |
| Electric connection | CB    | 1x20L |           |         | 400V 3N~9,2 kW 16A |
| Electric connection | CB    | 2x5   |           |         | 230V 1~3,2 kW 16A  |
| Electric connection | CB    | 2x10  |           |         | 400V 3N~6,2 kW 10A |
| Electric connection | CB    | 2x20  |           |         | 400V 3N~9,2 kW 16A |
| Waterconnection     |       |       |           |         | 3/4"               |

CB=CB

5=5, 1x5R=1x5R, 1x5L=1x5L, 2x5=2x5, 10=10, 1x10R=1x10R, 1x10L=1x10L, 2x10=2x10, 20=20, 1x20R=1x20R, 1x20L=1x20L, 2x20=2x20



**EG-Conformiteitsverklaring**  
*EC-declaration of conformity*  
**EG-Konformitätserklärung**  
*Certificat de conformité CE*

De firma  
*The company*  
Die Firma  
*La société*

**Animo B.V.**  
P.O.Box 71  
NL - 9400 AB Assen

verklaart, dat het produkt  
*certifies that the product*  
erklärt, daß das Produkt  
*certifie que le produit*

**Koffiezet-Installatie**  
*Coffeemaker*  
**Kaffeemaschine**  
*Machine à café*

met de type aanduiding  
*with the type designation*  
mit der Typbezeichnung  
*avec la désignation*

**CB 5, CB 10, CB 20**  
**CB 5W, CB 10W, CB 20W**

deze verklaring verwijst in overeenstemming te zijn, met de volgende EG-richtlijnen:  
*this declaration refers to corresponds with the following EC-directives:*  
auf das sich diese Erklärung bezieht, mit den nachfolgenden EG-Richtlinien übereinstimmt:  
*objet de cette declaration, est conforme aux directives européennes ci-dessous:*

**89/392/CEE**  
**89/336/CEE**  
**73/23/CEE**

gemodificeerd door  
*modified by*  
in der Fassung  
*modifié par la*

**93/68/CEE '94**

Toegepaste normen  
*Applied standards*  
Angewandte Normen  
*Normes appliquées*

**EN 60 335**  
**EN 55 014; EN 61000-3-2; EN 61000-3-3**

Assen, 2 februari 2004  
*Assen, 2. February 2004*  
Assen, den 2. Februar 2004  
*Assen, le 2 Février 2004*

  
\_\_\_\_\_  
Directie  
*General manager*  
Geschäftsführer  
*Directeur general*



**EG-Conformiteitsverklaring**  
*EC-declaration of conformity*  
**EG-Konformitätserklärung**  
*Certificat de conformité CE*

De firma  
*The company*  
Die Firma  
*La société*

**Animo B.V.**  
P.O.Box 71  
NL - 9400 AB Assen

verklaart, dat het produkt  
*certifies that the product*  
erklärt, daß das Produkt  
*certifie que le produit*

Koffiezet-installatie  
*Coffeemaker*  
Kaffeemaschine  
*Machine à café*

met de type aanduiding  
*with the type designation*  
mit der Typbezeichnung  
*avec la désignation*

**CB 2x5, CB 2x10, CB 2x20**  
**CB 2x5W, CB 2x10W, CB 2x20W**  
**CB 1x5 L/R, CB 1x10 L/R, CB 1x20 L/R**  
**CB 1x5W L/R, CB 1x10W L/R, CB 1x20W L/R**

deze verklaring verwijst in overeenstemming te zijn, met de volgende EG-richtlijnen:  
*this declaration refers to corresponds with the following EC-directives:*  
auf das sich diese Erklärung bezieht, mit den nachfolgenden EG-Richtlinien übereinstimmt:  
*objet de cette declaration, est conforme aux directives européennes ci-dessous:*

**89/392/CEE**  
**89/336/CEE**  
**73/23/CEE**

*gemodificeerd door*  
*modified by*  
in der Fassung  
*modifié par la*

**93/68/CEE '94**

Toegepaste normen  
*Applied standards*  
Angewandte Normen  
*Normes appliquées*

**EN 60 335**  
**EN 55 014; EN 61000-3-2; EN 61000-3-3**

Assen, 2 februari 2004  
*Assen, 2. February 2004*  
Assen, den 2. Februar 2004  
*Assen, le 2 Février 2004*

  
\_\_\_\_\_  
Directie  
*General manager*  
Geschäftsführer  
*Directeur general*



**EG-Conformiteitsverklaring**  
*EC-declaration of conformity*  
**EG-Konformitätserklärung**  
*Certificat de conformité CE*

De firma  
*The company*  
Die Firma  
*La société*

**Animo B.V.**  
P.O.Box 71  
NL - 9400 AB Assen

verklaart, dat het produkt  
*certifies that the product*  
erklärt, daß das Produkt  
*certifie que le produit*

**Koffiecontainer**  
*Coffecontainer*  
**Kaffeecontainer**  
*Conteneurs à café*

met de type aanduiding  
*with the type designation*  
mit der Typbezeichnung  
*avec la désignation*

**CNe 5, 10, 20**

deze verklaring verwijst in overeenstemming te zijn, met de volgende EG-richtlijnen:  
*this declaration refers to corresponds with the following EC-directives:*  
auf das sich diese Erklärung bezieht, mit den nachfolgenden EG-Richtlinien übereinstimmt:  
*objet de cette déclaration, est conforme aux directives européennes ci-dessous:*

**89/392/CEE**  
**89/336/CEE**  
**73/23/CEE**

*gemodificeerd door*  
*modified by*  
*in der Fassung*  
*modifié par la*

**93/68/CEE '94**

Toegepaste normen  
*Applied standards*  
Angewandte Normen  
*Normes appliquées*

**EN 60 335**  
**EN 55 014; EN 61000-3-2; EN 61000-3-3**

Assen, 2 februari 2004  
*Assen, 2. February 2004*  
Assen, den 2. Februar 2004  
*Assen, le 2 Février 2004*

  
\_\_\_\_\_  
Directie  
*General manager*  
Geschäftsführer  
*Directeur general*



**Conformiteitsverklaring - hygiënisch ontwerp**  
*declaration of conformity - hygienic design*  
**Konformitätserklärung - hygienischer Entwurf**  
*Certificat de conformité - hygiène*

De firma  
*The company*  
Die Firma  
*La société*

**Animo B.V.**  
P.O.Box 71  
NL - 9400 AB Assen

verklaart, dat het produkt  
*certifies that the product*  
erklärt, daß das Produkt  
*certifie que le produit*

Koffiecontainer  
*Coffee container*  
Kaffecontainer  
*Conteneurs à café*

met de type aanduiding  
*with the type designation*  
mit der Typbezeichnung  
*avec la désignation*

**CNI 5, 10, 20**

Het toepassings gebied van de container beslaat:

*The application area of the container covers:*

Das Anwendungsgebiet der Container umfaßt:

*Les conteneurs ont spécialement été conçus pour:*

**De opslag en distributie van warme en koude dranken op een constante temperatuur voor een bepaalde periode**

*The storage and distribution of hot and cold drinks at a constant temperature for a period of time*

**Das Aufbewahren und die Distribution von warmen und kalten Getränken auf einer konstanten Temperatur für eine bestimmte Zeit**

*la conservation et distribution de boissons chaudes et froides, tout en les maintenant à température constante pendant un moment déterminé*

deze verklaring verwijst in overeenstemming te zijn, met de volgende EG-richtlijnen:

*this declaration refers to corresponds with the following EC-directives:*

auf das sich diese Erklärung bezieht, mit den nachfolgenden EG-Richtlinien übereinstimmt:

*objet de cette declaration, la conformité aux directives européennes ci-dessous:*

**93/43/CEE**

Toegepaste normen en publicaties  
*Applied standards and publications*  
Angewandte Normen und Publikationen  
*Normes appliquées et publications*

**NEN-EN 1672-2**

**Publications of the European Hygienic Equipment Design Group (EHEDG)**

**The principle of Hazard Analysis Critical Control Points (HACCP)**

**IP 65 - EN 60529 / 1992-03 (IEC 529 : 1989)**

Assen, 2 februari 2004  
*Assen, 2. February 2004*  
Assen, den 2. Februar 2004  
*Assen, le 2 Février 2004*

  
\_\_\_\_\_  
Directie  
*General manager*  
Geschäftsführer  
*Directeur general*