

metos

GLASS DOOR BOTTLE COOLERS

METOS MAXIGLASS NOVERTA

4146700,4146702, 4146704, 4146706, 4146708, 4146710, 4146712, 4146714, 4146716, 4146718, 4146720, 4146722, 4146724,
4146726, 4146728, 4146730, 4146732, 4146734

USER MANUAL



Table of Contents

1.	Safety precautions	3
1.1.	Refrigerant.....	3
1.2.	During operation.....	3
1.3.	After use.....	3
2.	Product description	4
2.1.	Type plate	4
3.	Installation	5
3.1.	How does it work	5
3.2.	Installing the appliance.....	5
3.3.	Fitting storage racks	5
3.4.	Power supply.....	6
4.	Using the appliance	7
4.1.	Prior to use	7
4.2.	Thermostat.....	7
4.2.1.	Temperature setting	8
4.2.2.	Manual defrost	8
4.2.3.	The hidden menu	8
4.2.4.	Locking and locking of the keyboard.....	8
4.2.5.	Alarm signals.....	9
4.3.	Filling the cabinet	9
5.	Cleaning	10
6.	Troubleshooting.....	11
7.	Technical information.....	12

1. Safety precautions



Prior to use check

- whether the power supply is suitable for this product
- that the plug and the lead are not damaged
- ensure that the product is standing firmly and level



Hold the plug when removing the plug from the socket.
Always have repairs carried out by qualified service engineers.

1.1. Refrigerant



This product contains a refrigerant. The quality and quantity used in this product are stated on the type plate.

Large quantities of refrigerant can cause serious damages.

Always ensure that there is sufficient ventilation in the room where the appliance is located.

Refrigerant can cause frost injury.

1.2. During operation

- Only use this product for storing packed beverages.
- Never use the product as a step.
- Never store electrical appliances in the product.
- Always store beverages with a high percentage of alcohol standing upright and tightly closed.
- Ensure that ventilation grilles both in and outside the cabinet remain unobstructed.
- In case of emergency the plug should be removed from the socket.
- Ensure that the ambient temperature does not exceed the climate classification.

1.3. After use



The crossed-out wheeled bin means that within the European Union the product must be taken to separate collection at the product end-of life. This applies to your device but also to any enhancements marked with this symbol. Do not dispose of these products as unsorted municipal waste.

2. Product description

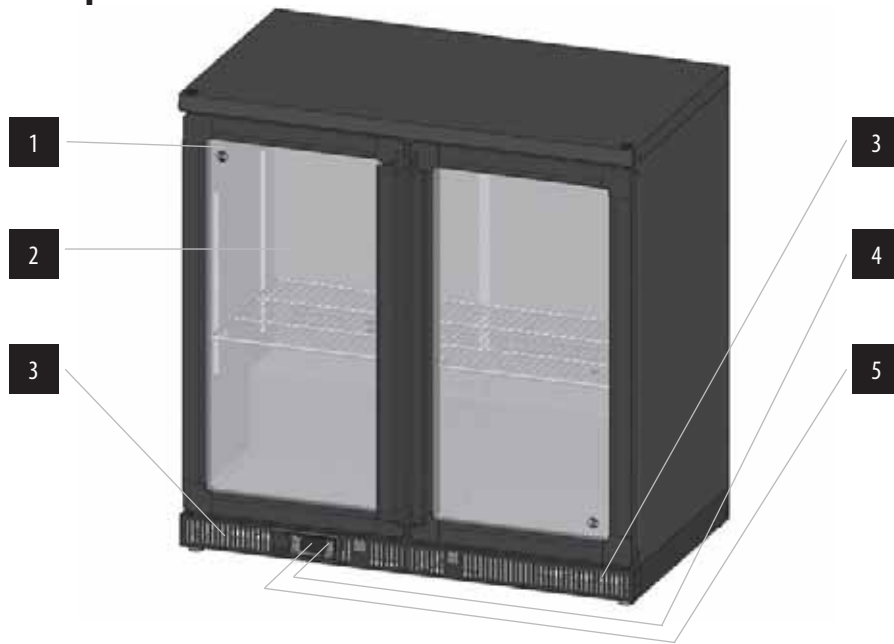

- 1 Type plate (inside)
- 2 Door
- 3 Air in/outlet
- 4 On/off switch
- 5 Thermostat

2.1. Type plate



- Type
- A** Refrigerant type + volume
- B** Power consumption
- C** Supply
- D** Rated current
- E** Climate classification *
- F** Construction year
- G** Unit serial number
- H**

*A refrigerator is produced for optimal performance within certain ambient temperatures. This product is suitable for the following classification: N: from +16 °C to +32 °C.

3. Installation



Never install the refrigerator next to a heat source.

3.1. How does it work

A refrigerator works by extracting heat from the space to be refrigerated and to release this in the surrounding area. For maximum air circulation it is recommended to allow at least 10 cm space around the refrigerator.



Be very careful never to obstruct the air inlets and outlets.

3.2. Installing the appliance

Place the appliance on a smooth surface.

1. Place the product at his position.
2. Make sure the product is standing level using a spirit level.
3. Use the adjustable feet to level the product.
4. To meet the ECA criterion of the M2 temperature class, the thermostat must be set at a set point of 1°C and the bottom shelf must be placed on the bottom of the cabinet.

3.3. Fitting storage racks

1. Hook pin (1) in openings (2) of rails (C).
2. Push bottom part (B) towards side (A).
3. This causes pin (3) to slot into the next opening (4) in the rails.
4. Fit the other pins at the same height.
5. Place the storage rack (D) sliding the pins (5) in the openings (6).

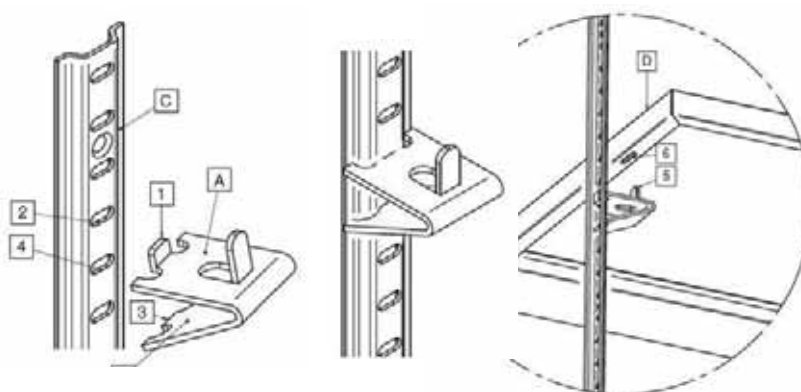

3.4. Power supply



- If this device cable is damaged it must be replaced with an original cable supplied by the producer.
- In case of emergency: remove the plug lead from the socket.
- The socket should be within easy reach of the cabinet.
- Check for the correct power supply, referred to the information on the type plate.
- Ensure that the plug lead cannot be trapped or snagged.
- If necessary the plug lead can be extended by a qualified electrician.
- We do not recommend the use of an extension lead.

Fluctuations in the power supply can cause damage, which causes the cabinet to switch off. The manufacturer cannot be held responsible for any consequential damage.



EMERGENCY STOP
REMOVE THE PLUG FROM THE SOCKET



4. Using the appliance

4.1. Prior to use

- Clean the cabinet prior to use. For further details we refer to the maintenance section.
- Leave the installation to stand for at least 2 hours before switching on the cabinet.
- Plug into a grounded power socket.

4.2. Thermostat



Key combination

⏏ + ⏏ To lock or unlock the keyboard

SET + ⏏ To enter in programming mode

SET + ⏏ Return to room temperature display

Icons and functions

❄	On	Compressor enabled
	Flashing	Compressor delay enabled
💡	On	Light output enabled
	Flashing	Light delay after defrosting
🌀	On	Fans output enabled
	Flashing	Fans delay after defrosting
°C, °F	On	Measurement unit
	Flashing	Programming mode
☀️🌙	On	Energy saving mode active
🔊	On	An alarm condition is present
	Flashing	Start-up operations are pending

Start-up operations lasts about 30 sec. after powering on device. At the end of this phase, the alarm icon will switch off if no alarm is active. Wait for the end of this interval of time before doing modifications on the parameter map.

4.2.1. Temperature setting

- Push and immediately release the SET key, the set point will be shown.
- Push and release of SET key or wait for 5 sec. to return to the normal view.

Change of setpoint

- Push the SET key for more than 2 sec and release, then push the SET key again.
- Setpoint value will be displayed and the "°C" LED starts blinking.
- To change the value push UP or DOWN key.
- To memorise the new value, push SET key three times or wait for 10 sec.

4.2.2. Manual defrost

Push the DEFROST button for more than 2 sec. to start defrosting.

4.2.3. The hidden menu

The hidden menu includes all the parameters of the instrument.

To enter the hidden menu

- Press the SET+DOWN buttons simultaneously for 3 sec. (°C or °F starts blinking)
- Release the buttons. Press again SET+DOWN for more than 7 secs. The L2 label will be displayed immediately followed from HY parameter.

You are now in the hidden menu

- Select the required parameter
- Press SET key to display its value.
- Use UP or DOWN button to change the value.
- Press SET to store the new value and move to the following parameter.

To exit, press SET+UP or wait for 15 sec. without pressing any key.

If there are no parameters in "L1", after 3 sec. the "nP" label will be displayed. Keep the keys pushed till the "L2" message will be displayed.

The previous set value will be stored even if the programming mode is exited by waiting for the time-out to expire.

Move parameters from the hidden menu to the first level and viceversa.

Each parameter present in the hidden menu can be removed or put into the user level (Fist level) by pressing SET+DOWN. If the parameter is visible also in user manu, the decimal poist will lit in the hidden menu.

4.2.4. Locking and locking of the keyboard

- To lock the keyboard, keep UP+DOWN pressed more than 3 secs.
- The OFF label will be displayed and the keyboard will be locked. If any button is pressed more than 3 secs, the OFF message will be displayed.
- To unlock, keep UP and DOWN buttons pressed together for more than 3 secs till the "ON" message will be displayed

4.2.5. Alarm signals

Mess.	Cause	Output
P1	Room probe failure	Compressor output according to Con e COF
P2	Evaporator probe failure	Defrost end is timed
P4	Condenser probe failure	Condenser temperature alarm is not managed
HA	Maximum temperature alarm	Outputs unchanged
LA	Minimum temperature alarm	Outputs unchanged
dA	Door open more than dA time	Compressor and fans retar

Alarm recovery

Probe alarms P1, P2 and P4 - Call service

Temperature alarms HA and LA automatically stop as soon as the temperature returns to normal value.

4.3. Filling the cabinet

- This product is only to be used for the refrigeration of packed beverages.
- Fill the cabinet during a period when it is least used. Repeatedly opening of the door will slow down the refrigeration of the products.
- Beverages with a high alcohol percentage should always be stored properly sealed in an upright position.

To guarantee optimal performance and air circulation the air vents of the cabinets should NEVER be obstructed.

NEVER use the cabinet to store electrical appliances.

Apply the so called first-in first-out principle when serving beverages out of the cabinet. This to ensure that the coldest product is served.

5. Cleaning

- Before first use the cabinet should be cleaned using water and a mild detergent.
- Intensive use requires regular cleaning.
- The MG1/** has a maintenance free condenser.
- Check and clean the magnetic seals on a regular basis. If the seal is not airtight it will have a negative effect on the refrigeration performance and it needs to be replaced immediately.

The machine must not be cleaned with a pressure washer, either inside or out.

When the floor is washed, water can splash up under the machine and damage the components. These have not been designed to withstand being washed with water. Do not wash the floor within 1 metre of the appliance.

Pressure washers have special protective cases which can be fitted to prevent water splashing.



Do not use aggressive abrasives or detergents.
Do not dismantle any fixed components when cleaning the machine unit.
The machine must not be cleaned with pressure water.



6. Troubleshooting



Always remove the plug from the socket when carrying out cleaning and repairs



The cabinet does not start.

- Check the plug.
- Restore the power supply by replacing a fault fuse or by using the on/off switch.
- Contact your local service.

Temperature is too high, in spite of recent adjustment of thermostat.

- Check/restore power supply.
- Remove contents which may obstruct ventilation.
- Clean magnetic seal, replace if necessary. Remove contents which may obstruct ventilation
- Defrost evaporator.
- Thermostat or compressor is defect.
- Fan (evaporator or condenser) is defect.
- Contact your local service.

Temperature is too low, in spite of recent adjustment of thermostat.

- Thermostat is defect.
- Contact your local service.

Water leak

- Defrost regularly - if necessary extra manual defrost cycle.
- Check if the product is leveled. If necessary level the product.
- Contact your local service.

Plug lead

- To prevent accidents the plug lead, if damaged, may only be replaced by the service/maintenance by qualified electrician.

7. Technical information





Power supply	220...240V /50 Hz / 1
Refrigerant	R134a
Cooling capacity	240W* (5,08CC)
Thermostate	Electronic
Temperature range	+1...18°C (set value +6°C)

TYPE	 MG1/140LG	 MG1/140LGCS	 MG1/140RG	 MG1/140RGCS
Power consumption	173 W*	173 W*	173 W*	173 W*
Volume	140 l	140 l	140 l	140 l
Weight	56 kg	56 kg	56 kg	56 kg
Illumination	1 x 3 W	1 x 3 W	1 x 3 W	1 x 3 W
Capacity tray	2x50 kg/door	2x 50 kg/door	2x 50 kg/door	2x 50 kg/door
Dims. incl. feet	602x506x840/850 mm			

TYPE	 MG1/150LG	 MG1/150LGCS	 MG1/150RG	 MG1/150RGCS
Power consumption	173 W*	173 W*	173 W*	173 W*
Volume	150 l	150 l	150 l	150 l
Weight	58 kg	58 kg	58 kg	58 kg
Illumination	1 x 3 W	1 x 3 W	1 x 3 W	1 x 3 W
Capacity tray	2x50 kg/door	2x 50 kg/door	2x 50 kg/door	2x 50 kg/door
Dims. incl. feet	602x506x900/910 mm			

TYPE	 MG1/150LD	 MG1/150LDDCS	 MG1/150RDD	 MG1/150RDDCS
Power consumptions	173 W*	173 W*	173 W*	173 W*
Volume	150 l	150 l	150 l	150 l
Weight	58 kg	58 kg	58 kg	58 kg
Illumination	1 x 3 W	1 x 3 W	1 x 3 W	1 x 3 W
Capacity tray	2x50 kg/door	2x 50 kg/door	2x 50 kg/door	2x 50 kg/ door
Dims. incl. feet	602x506x900/910 mm			

TYPE	 MG1/150SD
Power consumption	173 W*
Volume	150 l
Weight	58 kg
Illumination	1 x 3 W
Capacity tray	2x 50 kg/ door
Dims. incl. feet	602x506x900/910 mm

TYPE	 MG1/250G	 MG1/250GCS	 MG1/250DD	 MG1/250DDCS	 MG1/250SD
Power consumption	181 W*	181 W*	181 W*	181 W*	181 W*
Volume	250 l	250 l	250 l	250 l	250 l
Weight	77 kg	77 kg	77 kg	77 kg	77 kg
Illumination	1 x 4 W	1 x 4 W	1 x 4 W	1 x 4 W	1 x 4 W
Capacity tray	2x50 kg/ door	2x 50 kg/ door	2x 50 kg/ door	2x 50 kg/ door	2x 50 kg/ door
Dims. incl. feet	900x506x900/910 mm				

Power supply 220...240V /50 Hz / 1
 Refrigerant R134a
 Cooling capacity 240W* (5,08CC)
 Thermostate Electronic
 Temperature range +1...18°C (set value +6°C)

TYPE	 MG1/275G	 MG1/275GCS	 MG1/275SD
Power consumption	316 W*	316 W*	316 W*
Volume	275 l	275 l	275 l
Weight	94 kg	94 kg	94 kg
Illumination	1 x 4 W	1 x 4 W	1 x 4 W
Capacity tray	2x50 kg/door	2x 50 kg/door	2x 50 kg/door
Dims. incl. feet	1200x506x900/910 mm		

TYPE	 MG1/315G	 MG1/315GCS	 MG1/315SD
Power consumption	316 W*	316 W*	316 W*
Volume	315 l	315 l	315 l
Paino	103 kg	103 kg	103 kg
Illumination	1 x 4 W	1 x 4 W	1 x 4 W
Capacity tray	2x50 kg/door	2x50 kg/door	2x 50 kg/door
Dims. incl. feet	1350x526x900/910 mm		



CE declaration of conformity for machines

(directive 2006/42/EC, Appendix II, sub A)

Manufacturer: Gamko BV
Address: Mon Plaisir 75
4879 AL, Etten-Leur
The Netherlands

Herewith declares that

Gamko product range type:

- MG1^{AX}

Is provided as defined in:

- The EC machines (Directive 2006/42/EC)
- Electromagnetic compatibility (Directive 2004/108/EEC)
- Directive low-voltage (Directive 2006/95/EEC)
- PED pressurised equipment (Directive 97/23/EC)
- RoHS directive (2002/95/EC)

Etten-Leur, 06 - 03 - 2012

A handwritten signature in black ink, appearing to be "N. Govers", written over a light grey circular stamp.

N. Govers
Manager R&D

metos
kitchen intelligence®