

# metos

## DROP-IN DISPENSERS

PLATE DISPENSER D-I PDW  
PLATE DISPENSER D-I PD  
BASKET DISPENSER D-I BD  
TRAY DISPENSER D-I TD  
CUTTING BOARD D-I

Accessories  
ADJUSTMENT RODS

---

## Installation and Operation Manual

---



---

S/N:

Valid from: 03. 03. 2008

Rev.: 2.0

D-I PDW 4138944, 4138946  
D-I PD 4138940, 4138942  
D-I BD 4138553, 4138555  
D-I TD 4138578, 4138580  
D-I cutting board 4138714  
adjustment rods 4203972, 4203970



Dear Customer,

Congratulations on deciding to choose a Metos equipment for your kitchen activities. You made an excellent choice. We will do our best to make also you a satisfied Metos customer like thousands and thousands of others all over the world.

Please read this manual carefully. You will learn many right, safe and efficient working methods in order to get the best possible benefit from the equipment. The instructions and hints in this manual will give you a quick and easy start in using this equipment. You will note very quickly how nice it is to use the Metos equipment.

All rights are reserved for technical changes.

You will find all the main technical data on the rating plate fixed to the equipment. When you need service or technical help, please let us know the serial number of the equipment. This will make it easier to provide you with the correct service. Please write the contact information of your local Metos service in advance on the lines below.

**METOS TEAM**

Metos service phone number:.....

Contact person:.....



<b>1. General .....</b>	<b>1</b>
1.1 Symbols used in the manual .....	1
1.2 Symbols used on the appliance .....	1
1.3 Checking the relationship of the appliance and the manual .....	1
<b>2. Safety .....</b>	<b>2</b>
2.1 Safe use of the appliance (D-I PDW) .....	2
2.2 Disposal of the appliance .....	2
<b>3. Functional description .....</b>	<b>3</b>
3.1 Intended use of the appliance .....	3
3.1.1 Plate dispensers .....	3
3.1.2 Basket dispensers .....	3
3.1.3 Tray dispensers .....	3
3.1.4 Use for other purposes .....	3
3.2 Operating switches (D-I PDW) .....	4
<b>4. Operating instructions .....</b>	<b>5</b>
4.1 Operation .....	5
4.2 After use .....	5
4.2.1 Cleaning .....	5
<b>5. Installation .....</b>	<b>6</b>
5.1 Operating conditions .....	6
5.2 Transport and storage .....	6
5.3 Unpacking the appliance .....	6
5.4 Installation .....	6
5.4.1 Materials .....	6
5.4.2 Drop-in installation - General .....	7
5.4.3 Drop-in installation - PD models .....	7
5.4.4 Connections .....	8
5.4.5 Service door (D-I PDW) .....	8
5.5 Electrical connections (D-I PDW) .....	8
5.6 Start-up (D-I PDW) .....	8
5.7 Temperature adjustment (D-I PDW) .....	8
5.8 Adjustment of spring mechanism .....	9
5.9 Diameter adjustment (accessory) .....	10
<b>6. Troubleshooting .....</b>	<b>11</b>
<b>7. Technical specifications .....</b>	<b>13</b>



# 1. General

Carefully read the instructions in this manual as they contain important information regarding proper, efficient and safe installation, use and maintenance of the appliance.

Keep this manual in a safe place for eventual use by other operators of the appliance.

The installation of this appliance must be carried out in accordance with the manufacturer's instructions and following local regulations. The connection of the appliance to the electric and water supply must be carried out by qualified persons only.

Persons using this appliance should be specifically trained in its operation.

Switch off the appliance in case of failure or malfunction. The periodical function checks requested in the manual must be carried out according to the instructions. Have the appliance serviced by a technically qualified person authorized by the manufacturer and using original spare parts.

Not complying with the above may put the safety of the appliance in danger.

## 1.1 Symbols used in the manual



This symbol informs about a situation where a safety risk might be at hand. Given instructions are mandatory in order to prevent injury.



This symbol informs about the right way to perform in order to prevent bad results, appliance damage or hazardous situations.



This symbol informs about recommendations and hints that help to get the best performance out of the appliance.

## 1.2 Symbols used on the appliance



This symbol on a part informs about electrical terminals behind the part. The removal of the part must be carried out by qualified persons only.

## 1.3 Checking the relationship of the appliance and the manual

The rating plate of the appliance indicates the serial number of the appliance. If the manuals are missing, it is possible to order new ones from the manufacturer or the local representative. When ordering new manuals it is essential to quote the serial number shown on the rating plate.

## 2. Safety

### 2.1 Safe use of the appliance (D-I PDW)



For safe use of the appliance, observe the following safety instructions.

- The plate dispenser is a heated appliance. Therefore, beware of hot surfaces during use.
- When moving or servicing the appliance, always disconnect it from the power supply.
- While cleaning the appliance, be cautious not to allow the electrical devices to come into contact with water. Spraying water in the immediate vicinity of the appliance is forbidden.
- Exposing the appliance to the rain is forbidden.

If the appliance is not used for a long time, it should be disconnected from the power supply, cleaned and wiped dry on the inside.

### 2.2 Disposal of the appliance

The appliance contains parts and components, the disposal of which requires special treatment. Contact local authorities to obtain instructions on how to dispose of the appliance.



## 3. Functional description

### 3.1 Intended use of the appliance

The units are intended for storage and distribution of plates, trays and dishwashing baskets in serving lines.

#### 3.1.1 Plate dispensers

On models fitted with two cylinders the maximum plate diameter is 270 mm.

On models fitted with one cylinder the maximum plate diameter is 320 mm.

Heated models (D-I PDW) can be used for both storage and heating of plates.

Models PD are neutral, without heating.

#### 3.1.2 Basket dispensers

The unit is fitted with one cylinder, in which dishwashing baskets with max. dimensions of 500 x 500 mm can be placed.

#### 3.1.3 Tray dispensers

The unit is fitted with one cylinder, where 430 x 325 mm trays can be placed.



The manufacturer shall not be held liable for situations which may arise from failure to comply with the warnings and instructions given in this manual.

#### 3.1.4 Use for other purposes



Use of the appliance for any other purposes is prohibited.

Consult the manufacturer in case you intend to use the appliance for other purposes than stated above.

### 3.2 Operating switches (D-I PDW)

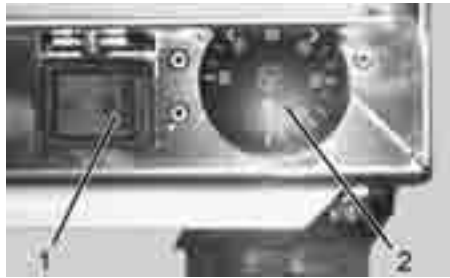

*Operating panel*

1. Heating element switch
2. Heating element thermostat knob

## 4. Operating instructions

### 4.1 Operation

Put the plates in the cylinder. If the model is equipped with adjustment bars, adjust them to suit the plate size.

**D-I PDW:** Switch on the heating (see “Functional description/Operating switches”) in good time before use. If you change the plate size during operation, adjust the diameter and spring pressure as needed (see “Installation/Adjustment of spring mechanism and Diameter adjustment”).

The appliance is fitted with thermostatic control, which means that the user does not need to take care about temperature once set with the thermostat.

### 4.2 After use

#### 4.2.1 Cleaning

In normal use, the appliance does not need any other daily care than sufficient cleaning.

The outer and inner surfaces of the appliance are mainly of stainless steel. Clean the appliance with neutral or slightly alkaline detergents or wipe with a damp cloth. Abrasive materials should not be used.



Using a hose for cleaning the appliance is forbidden, because water sprayed can get onto the operating panel, thus causing a hazardous situation.



Before cleaning, always unplug the appliance from the power supply.

## 5. Installation

### 5.1 Operating conditions

The appliance is designed for operation at temperatures of +10° C to +40° C.

### 5.2 Transport and storage

The appliance should be transported to the installation site in its transport package. Do not remove packing until in the immediate vicinity of the installation place.

The appliance is made of polished stainless steel that can become scratched very easily in site conditions. Therefore, the appliance should be delivered to the installation site at a later stage of construction work. It is forbidden to use the appliance as an installation base.

### 5.3 Unpacking the appliance

Remove plastic films protecting the stainless steel surfaces. Be careful that the surfaces do not become scratched.

### 5.4 Installation

Drop-in units are installed inside a separately built counter. The counter must be fitted with an installation opening; for measurements, see drawings in “Technical specifications” at the end of this manual. Sufficient space must be provided under the table top according to the installation drawings (see “Technical specifications”).

Drop-in units are lifted into the installation opening, so that they rest on the table top with their own weight.

A sufficient number of people is needed for lifting to avoid damaging the counter or the unit.

#### 5.4.1 Materials

The counter, where drop-in units are installed, must be damp-proof. Recommended material is, for instance, laminate-coated damp-proof chipboard. Extremely important is the choice of material for the table top.

The counter must be strong enough to bear the appliance weight. The weight of the appliance during operation must also be considered when designing the counter structure.

## Installation

---

### 5.4.2 Drop-in installation - General

Drop-in units have a 15 mm tall collar, which remains lying on the table top.

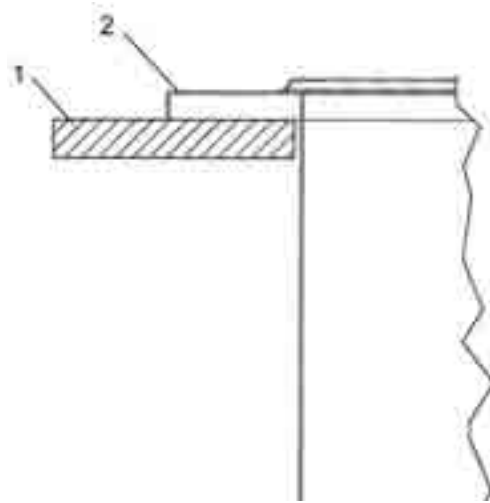

1. Table top
2. Dispenser

Because of the installation method, the table top must be completely flat, so that the edges of drop-in units rest evenly on the table surface. This is to ensure that dirt does not gather between the table top and the drop-in unit, and water does not enter the counter structure.

The drop-in unit is mounted on the table top with its own weight, and no separate insulation is required. If desired, the junction of the drop-in unit and table top can be sealed with silicone.

If you want to have the collar of the drop-in unit flush with the table top, you can make a recess for the collar in the table top. In this case you should make sure that the table top thickness is greater than the collar height (15 mm) and that the table top material is strong enough.

Space needed for installing the drop-in units should be taken into account: there must be enough free space above the drop-in opening for installation. Upper parts, eventually constructed separately, should be installed after the drop-in units are in place.

### 5.4.3 Drop-in installation - PD models

When installing neutral plate dispensers, an installation frame should be mounted in the drop-in opening before lowering the cylinders. Bend down the eight tongues of the installation frame and then mount the frame. The tongues set the frame in the opening correctly. After this the cylinders are lowered into the installation frame.

## 5.4.4 Connections

When constructing the counter, an opening for the connection cable must be considered. The opening must be at least the size of a plug (diameter min. 40 mm). In addition, the edges of the opening must be finished to make sure that the connection cable is not damaged by rubbing against the opening edge.

The length of the connection cable supplied with drop-in units is 3,2 m. When building the counter, it is advisable to design a special place for the extra length of the connection cable in the counter structure.

## 5.4.5 Service door (D-I PDW)

The operating switches of drop-in units are fixed to the units as standard. To facilitate the use of the switches, the counter must be fitted with a service door. The location of the service door is shown on the drawings at the end of this manual (see “Technical specifications”).

It is also possible to position the operating switches outside the counter, if specifically ordered from the manufacturer. In this case the drop-in units are delivered with electric cables of a sufficient length, to which the operating switches have been attached. An opening must then be made in the counter for the switches.

## 5.5 Electrical connections (D-I PDW)

Connect the appliance to the power supply with an earthed socket. For making the connection, a socket protected with a fuse of max. 16 A has to be provided for each unit.

## 5.6 Start-up (D-I PDW)

After connecting the appliance to the power supply, turn on the heating element switch and make sure that the indicator light of the switch goes on. Select the temperature using the thermostat knob (see “Functional description/Operating switches”).

In case you have problems with taking the appliance into use, contact your authorized service provider.

## 5.7 Temperature adjustment (D-I PDW)

Temperature is adjusted by turning the thermostat knob.

## 5.8 Adjustment of spring mechanism

Switch off the appliance (D-I PDW).



To access the springs, press an empty cylinder with your hand.

There is a hole in the dish platform for reserve springs to keep them in place.



Hold the spring with a firm grip and set it in the position desired.

The spring is placed in a C-shaped notch located in the cover.

Spring pressure should be distributed as evenly as possible on the whole lifting mechanism. Use an equal number of springs on both sides.

## 5.9 Diameter adjustment (accessory)



Detach the dispenser cover by un-twisting the support bars (4 pcs/cylinder) which hold the cover in place.



Slide the adjustment rods (4 pcs/cylinder) in place. You do not need to remove the cylinder from the appliance.



Lift the rod and turn it into the position desired. There are guide studs at the upper and lower end of the adjustment rod to ensure the correct location of the rod.

Do not switch the appliance on until the dispenser mechanism is in its correct place in the unit (D-I PDW).

Adjustment options for 270 mm cylinders: 180/200/220/235/270 mm

Adjustment options for 320 mm cylinders: 240/250/270/285/320 mm



## 6. Troubleshooting

In case the appliance does not function as expected, review the following list of problems to find out if the appliance can be put in order without a service call. In all enquiries, please contact your authorized service provider.

PROBLEM	POSSIBLE CAUSE	ACTION
The appliance does not start even if the main switch is turned on.	Electrical cable is not properly plugged in the socket.	Put the cable properly in the socket.
	Defective fuse.	Replace the fuse.



The appliance does not contain parts that can be serviced by the user. Service must be carried out by an authorised service company.



## **7. Technical specifications**

**Connection diagram S00257 A3, D-I PDW**

**Installation drawing D-I PDW 2x270**

**Installation drawing D-I PD 2x270**

**Installation drawing D-I PDW 2x270**

**Installation drawing D-I BD**

**Installation drawing D-I TD**

**Installation drawing D-I Cutting Board**

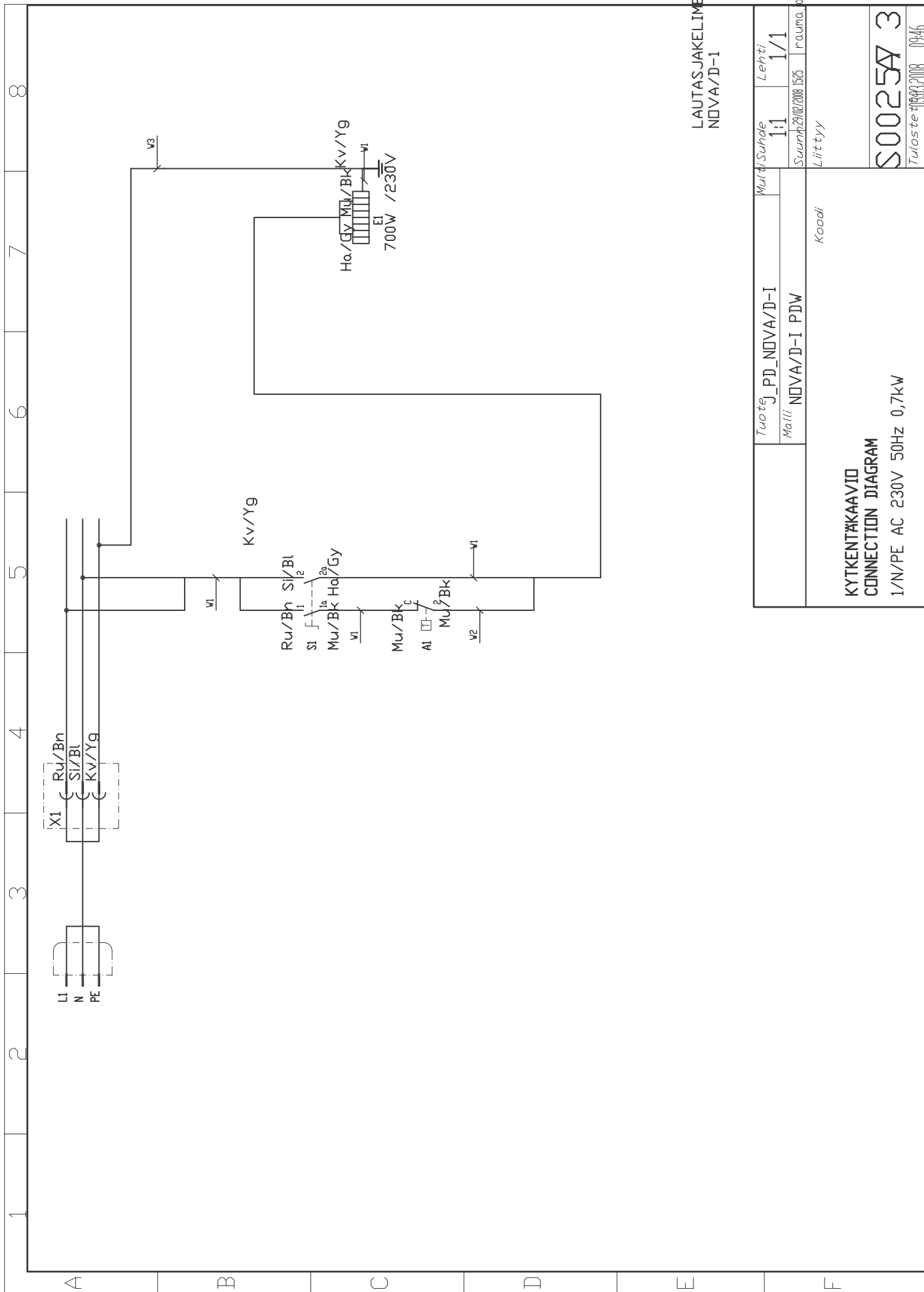

LAUTASJAKELIMET  
NOVA/D-1

Tuote	J_PD_NOVA/D-I	Muittu/Suhde	1:1	Lehti	1/1
Malli	NOVA/D-I PDW	Suunniteltu/2008	1525	rauma	0
Koodi Litty					
KYTENTÄKAAVIO CONNECTION DIAGRAM 1/N/PE AC 230V 50Hz 0,7kW					
S00257 3					
Tuloste/09032008					
0946					

Connection diagram S00257 A3, D-I PDW

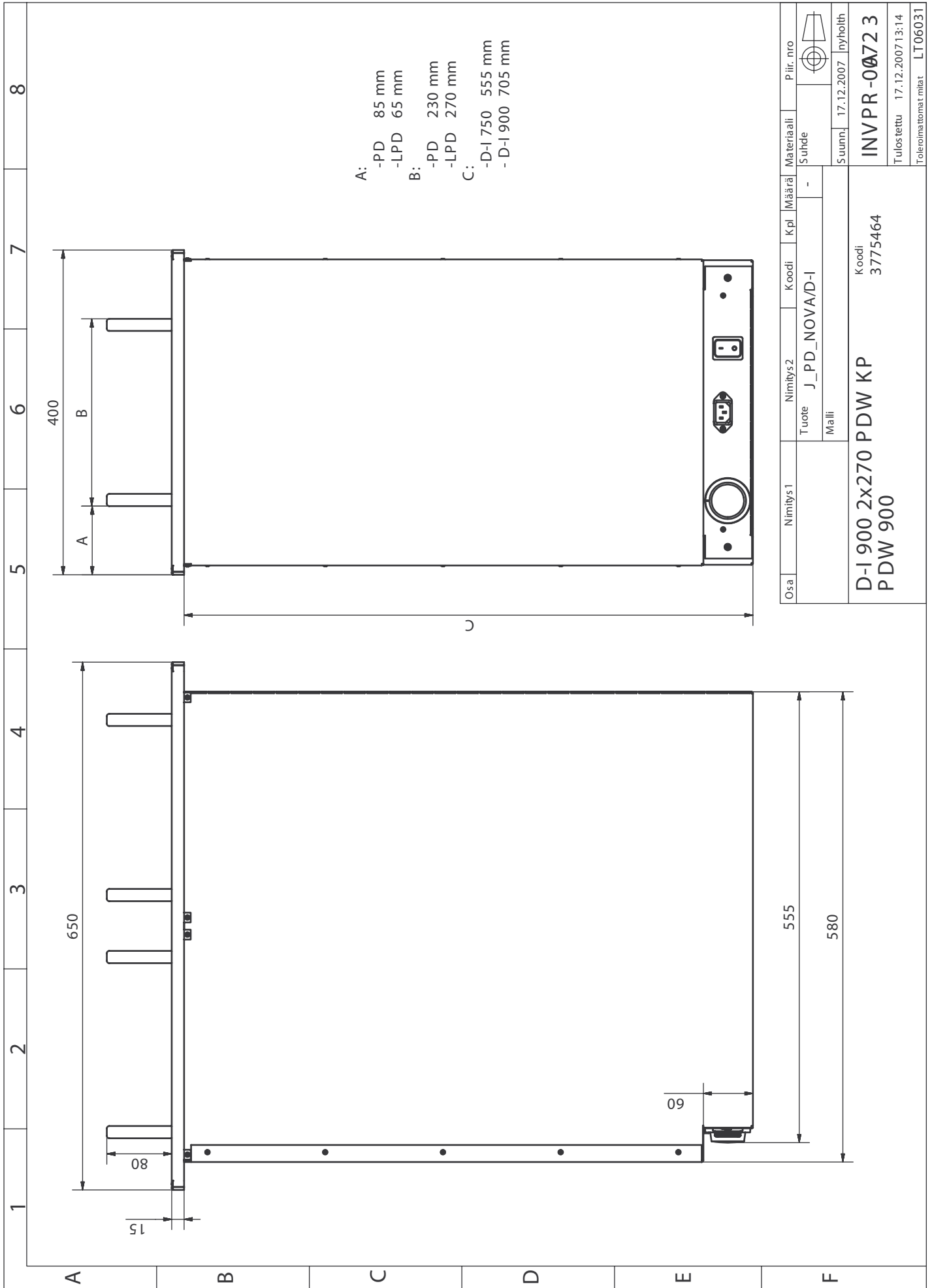

Installation drawing D-I PDW 2x270

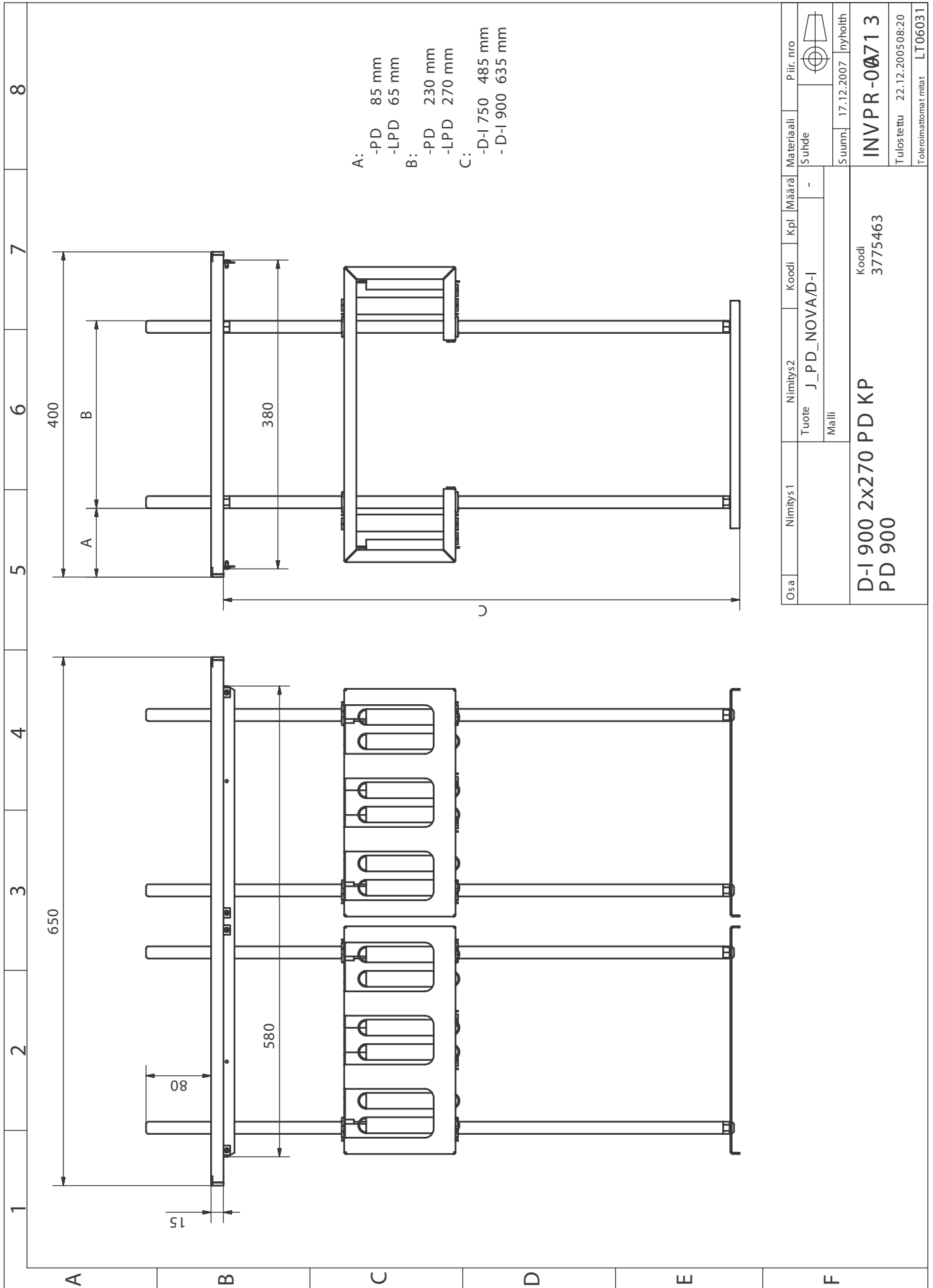

Installation drawing D-I PD 2x270

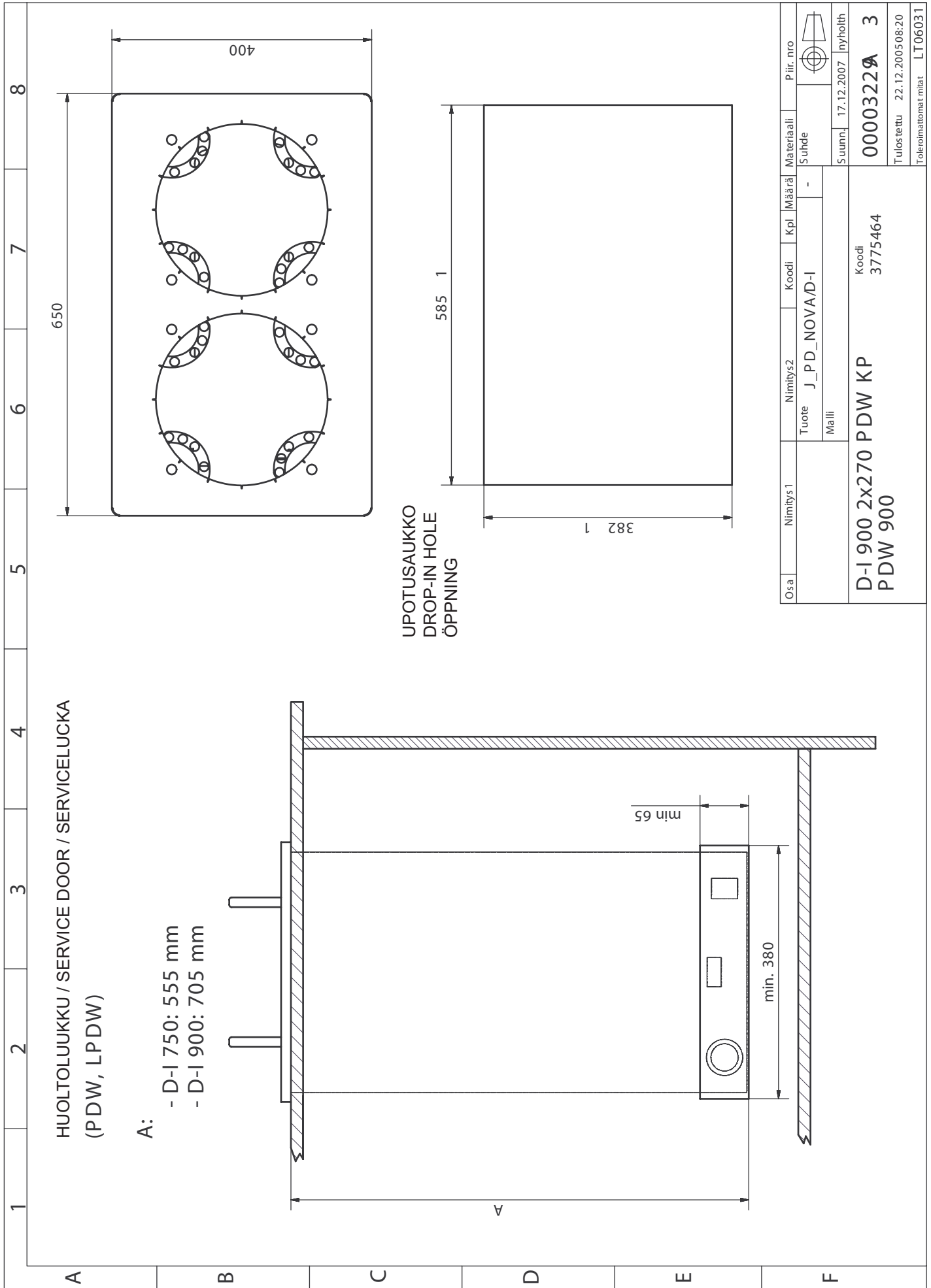

Installation drawing D-I PDW 2x270

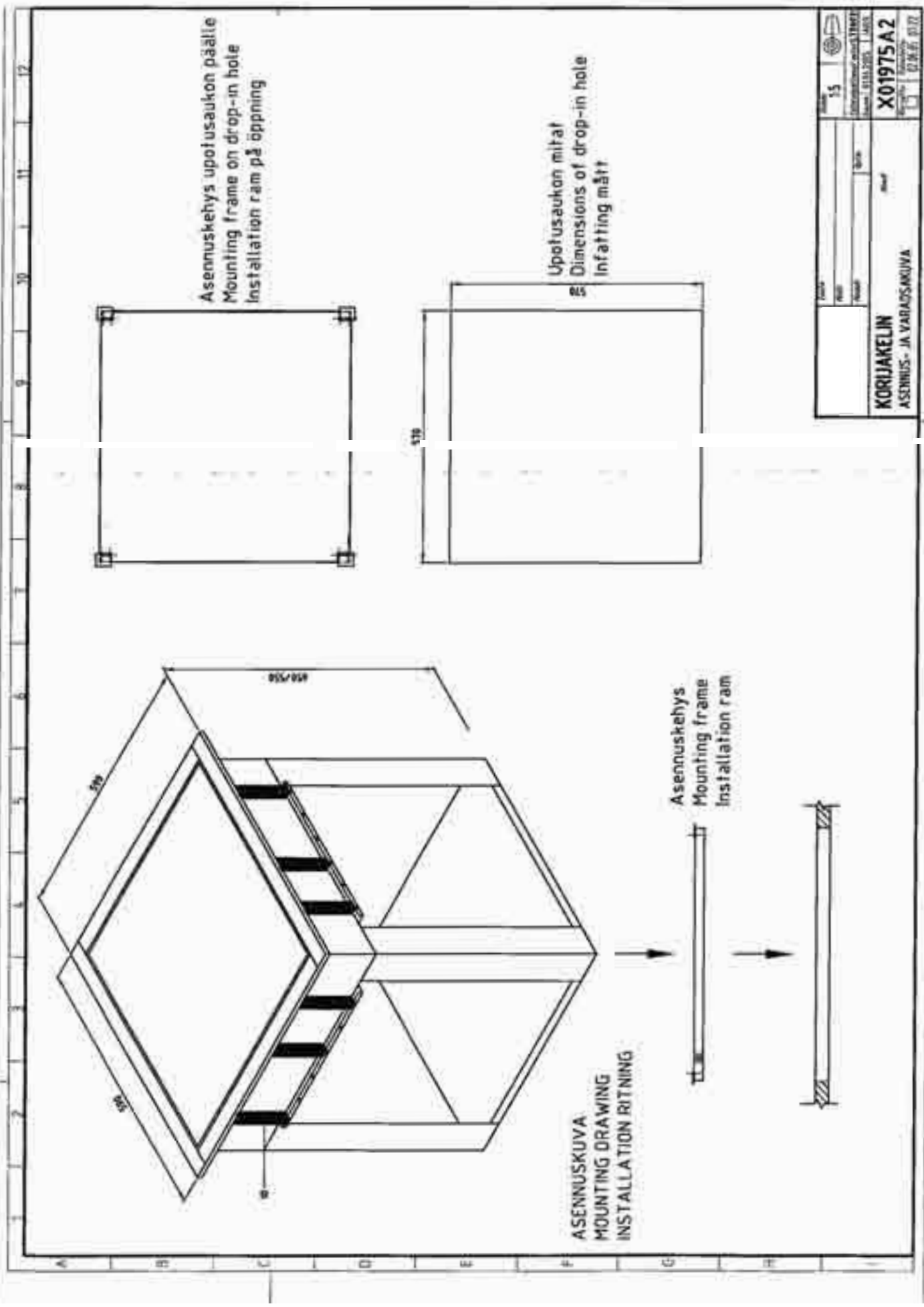

Asennuskehys upotusaukon päälle  
 Mounting frame on drop-in hole  
 Installation ram på öppning.

Upotusaukon mitat  
 Dimensions of drop-in hole  
 Infatting mått

ASENNUSKUVA  
 MOUNTING DRAWING  
 INSTALLATION RITNING

Asennuskehys  
 Mounting frame  
 Installation ram

Piste Wall Ruusut Grid	Koko Size 15	
KORIAKELIN ASENNUS- JA VARASTAJA		
Koko Size X01975A2		Päivä Date 02.06.07

Installation drawing D-I BD



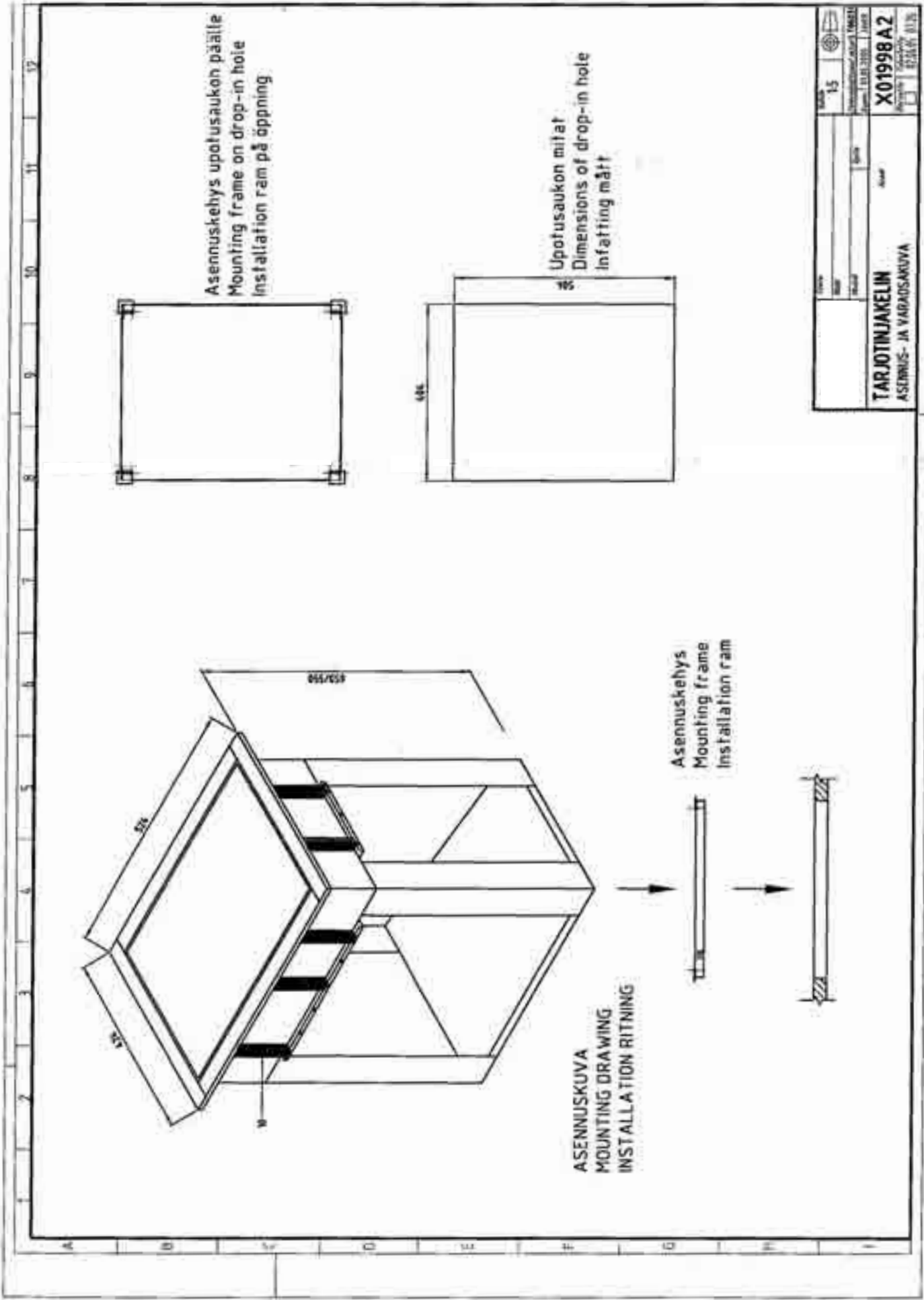

Asennuskehys upotusaukon päälle  
 Mounting frame on drop-in hole  
 Installation ram på öppning

Upotusaukon mitat  
 Dimensions of drop-in hole  
 Infattning mått

ASENNUSKUVA  
 MOUNTING DRAWING  
 INSTALLATION RITNING

Asennuskehys  
 Mounting frame  
 Installation ram

Scale	15
Project No.	X01998 A2
Author	
Check	
Approved	
Project Name	TARJOTINJAKELIN ASENNUS- JA VARAUSKUVA

Installation drawing D-I TD

1 2 3 4 5 6 7 8

A

B

C

D

E

F

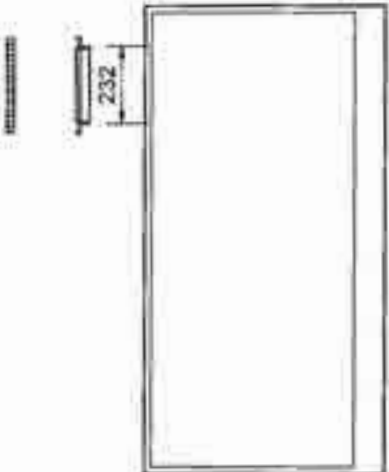
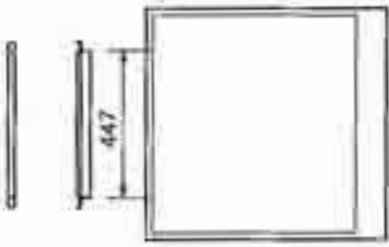
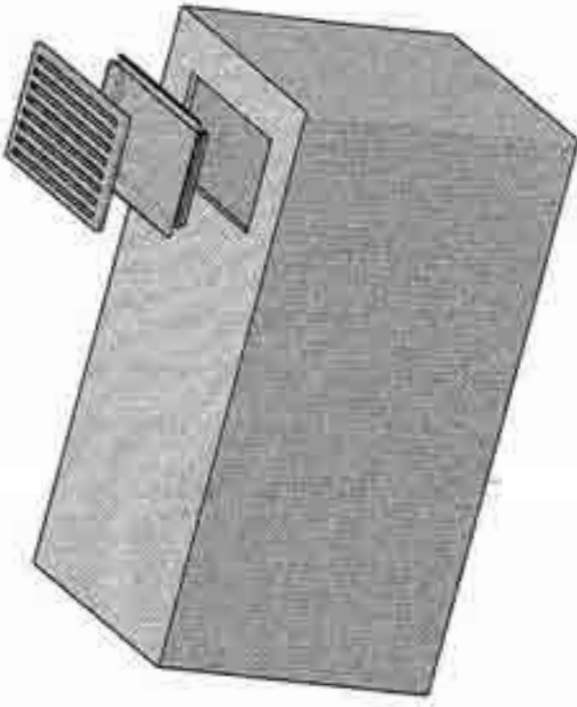

Upotusaukon mitta 232x447

Mittaus 1	Mittaus 2	Mittaus 3	Mittaus 4	Mittaus 5	Mittaus 6	Mittaus 7	Mittaus 8
Tyyppi		Materiaali		Koodi		Mittaus	
Malli							
K00234 A.0 3				Koodi			
Tilastointi 10.3.2004 17:28				Leikkulaikkip			
Tilausnro 12.8.2008				L106001			

## Technical specifications

---

Item	Model	Specification
Electric connection	PDW	230V 50Hz
Power input	PDW	0,7 kW
Temperature range	PDW	10...90°C
Temperature adjustment	PDW	Thermostat
Exterior		Stainless steel
Interior		Stainless steel

PDW=PLATE DISPENSER D-I PDW, PD=PLATE DISPENSER D-I PD, RD=BASKET DISPENSER D-I BD, TD=TRAY DISPENSER D-I TD, BT=CUTTING BOARD D-I

AB=ADJUSTMENT RODS

Päiväys / Datum / Date

3.3.2008

Me / Vi / We

Valmistajan nimi / Tillverkarens namn / Manufacturer's name

**METOS OY AB**

Osoite / Adress / Address

**AHJONKAARRE**  
**04220 KERAVA**  
**FINLAND**

vakuutamme yksinomaan omalla vastuullamme, että seuraava tuote:  
försäkrar helt på eget ansvar att följande produkt:  
declare under our sole responsibility that the product:

Nimi, tyyppi tai malli / Namn, typ eller modell / Name, type or model

Drop-in lautasjakelin / Drop-in tallriksdispenser / Drop-in plate dispenser  
D-I PD  
D-I PDW  
D-I LPD  
D-I LPDW

Drop-in korijakelin / Drop-in korgdispenser / Drop-in basket dispenser  
D-I BD-900  
D-I BD-750

Drop-in tarjotinjakelin / Drop-in brickdispenser / Drop-in tray dispenser  
D-I TD-900  
D-I TD-750

johon tämä vakuutus liittyy, on (mikäli asiankuuluvaa) seuraavan standardin (seuraavien standardien) tai muun normatiivisen asiakirjan (muiden normatiivisten asiakirjojen) vaatimusten mukainen  
till vilken denna försäkran hör, uppfyller (vid behov) kraven i följande standard (standarder) eller annat (andra) normativa dokument

to which this declaration relates is in conformity with (if necessary) the following standard(s) or other normative document(s)

Tunnus, vuosiluku tai julkaisupäivä / Beteckning, årtal eller publiceringsdatum / Designation or number, year or date of issue

EN-SFS 60335-1: 1995  
EN-SFS 50081-1: 1992  
EN-SFS 50082-1: 1995

ja noudattaa (mikäli asiankuuluvaa) seuraavan direktiivin (seuraavien direktiivien) määräyksiä  
och följer (vid krav) följande direktivs bestämmelser  
and in conformity with (if necessary) orders of following directive(s)

LVD 73/23 ja lisäys 93/68  
EMC 89/336/EEC sekä lisäykset 92/31 ja 93/68

Vakuutuksen antopaikka ja päivä / Utfärdad på ort och datum / Place and date of issue

**KERAVA 3.3.2008**

Valtuutetun henkilön nimi, nimikirjoitus ja asema / Bemyndigad persons namn, namnteckning och befattning / Name, signature and title of authorized person



**Tero Kähärä**  
**R&D Manager**



**Jari Paatola**  
**Plant Manager**